

HEAT SOURCE UNITS

1. SPECIFICATIONS	2 - 334
2. EXTERNAL DIMENSIONS	2 - 347
3. CENTER OF GRAVITY	2 - 350
4. ELECTRICAL WIRING DIAGRAMS	2 - 351
5. SOUND LEVELS	2 - 352
6. CAPACITY TABLES	2 - 356
6-1. Correction by temperature	2 - 356
6-2. Correction by total indoor	2 - 370
6-3. Correction by refrigerant piping length	2 - 377
6-4. Operation temperature range	2 - 381
7. SYSTEM DESIGN GUIDE	2 - 382
7-1. Designing of water circuit system	2 - 382
7-2. Water piping work	2 - 394
8. OPTIONAL PARTS	2 - 396
8-1. JOINT	2 - 396
8-2. HEADER	2 - 398
8-3. OUTDOOR TWINNING KIT	2 - 399

1. SPECIFICATIONS

DATA G8

Model			PQHY-P200YHM-A	PQHY-P250YHM-A	
Power source			3-phase 4-wire 380-400-415V 50/60Hz		
Cooling capacity (Nominal)	*1	kW	22.4	28.0	
	*1	kcal / h	19,300	24,100	
	*1	BTU / h	76,400	95,500	
		Power input	kW	3.92	5.45
		Current input	A	6.6-6.2-6.0	9.2-8.7-8.4
		COP	kW / kW	5.71	5.13
Temp. range of cooling	Indoor	W.B.	15.0 ~ 24.0°C(59 ~ 75°F)		
	Circulating water	°C	10.0 ~ 45.0°C(50 ~ 113°F)		
Heating capacity (Nominal)	*2	kW	25.0	31.5	
	*2	kcal / h	21,500	27,100	
	*2	BTU / h	85,300	107,500	
		Power input	kW	4.12	5.80
		Current input	A	6.9-6.6-6.3	9.7-9.3-8.9
		COP	kW / kW	6.06	5.43
Temp. range of heating	Indoor	D.B.	15.0 ~ 27.0°C(59 ~ 81°F)		
	Circulating water	°C	10.0 ~ 45.0°C(50 ~ 113°F)		
Indoor unit connectable	Total capacity	50 ~ 130 % of heat source unit capacity		50 ~ 130 % of heat source unit capacity	
	Model / Quantity	P15 ~ P250 / 1 ~ 17		P15 ~ P250 / 1 ~ 21	
Sound pressure level (measured in anechoic room)	dB <A>	47		49	
Refrigerant piping diameter	Liquid pipe	mm (in.)	9.52(3/8) Brazed		
	Gas pipe	mm (in.)	19.05(3/4) Brazed		
Circulating water	Water flow rate	m ³ / h	5.76		
		L / min	96		
		cfm	3.4		
	Pressure drop	kPa	17		
	Operating volume range	m ³ / h	4.5 ~ 7.2		
Compressor	Type x Quantity	Inverter scroll hermetic compressor			
	Manufacture	AC&R Works, MITSUBISHI ELECTRIC CORPORATION		AC&R Works, MITSUBISHI ELECTRIC CORPORATION	
	Starting method	Inverter			
	Motor output	kW	4.6		
	Case heater	kW	0.035(240 V)		
	Lubricant	MEL32			
External finish	Acrylic painted steel plate				
External dimension HxWxD	mm	1,160(1,100 without legs) x 880 x 550		1,160(1,100 without legs) x 880 x 550	
	in.	45-11/16(43-5/16 without legs) x 34-11/16 x 21-11/16		45-11/16(43-5/16 without legs) x 34-11/16 x 21-11/16	
Protection devices	High pressure protection	High pressure sensor, High pressure switch at 4.15MPa (601 psi)		High pressure sensor, High pressure switch at 4.15MPa (601 psi)	
	Inverter circuit (COMP.)	Over-heat protection, Over-current protection			
	Compressor	Over-heat protection			
Refrigerant	Type x original charge	R410A x 5.0kg (12lbs)			
	Control	Indoor LEV and BC controller			
Net weight	kg (lbs)	195(430)		195(430)	
Heat exchanger		plate type			
	Water volume in plate	l	5.0		
	Water pressure Max.	MPa	2.0		
HIC circuit (HIC: Heat Inter-Changer)		-			
Drawing	External	KB94T222		KB94T222	
	Wiring	KE94C317		KE94C317	
Standard attachment	Document	Installation Manual		Installation Manual	
	Accessory	Refrigerant conn. pipe			
Optional parts		Joint: CMY-Y102S-G2		Joint: CMY-Y102S-G2, CMY-Y102L-G2	
		Header: CMY-Y104/108/1010-G		Header: CMY-Y104/108/1010-G	
Remarks	<ul style="list-style-type: none"> •Details on foundation work, duct work, insulation work, electrical wiring, power source switch, and other items shall be referred to the Installation Manual. •Due to continuing improvement, above specifications may be subject to change without notice. •The ambient temperature of the heat source unit needs to be kept below 40°C D.B. •The ambient relative humidity of the heat source unit needs to be kept below 80%. •The heat source Unit should not be installed at outdoor. •Be sure to mount a strainer (more than 50 meshes) at the water inlet piping of the unit. •Be sure to provide interlocking for the unit operation and water circuit. 				

Notes :	Unit converter
1.Nominal cooling conditions(subject to JIS B8615-1) Indoor:27°CDB/19°CWB(81°FDB/66°FWB), Water temperature:30°C(86°F) Pipe length:7.5m(24-9/16ft.), Level difference:0m(0ft.)	kcal =kW x 860 BTU/h =kW x 3,412
2.Nominal heating conditions(subject to JIS B8615-1) Indoor:20°CDB(68°FDB), Water temperature:20°C(68°F) Pipe length:7.5m(24-9/16ft.), Level difference:0m(0ft.)	cfm =m ³ /min x 35.31 lbs =kg / 0.4536
	*The specification data is subject to rounding variation.

1. SPECIFICATIONS

DATA G8

Model		PQHY-P300YHM-A		
Power source		3-phase 4-wire 380-400-415V 50/60Hz		
Cooling capacity (Nominal)	*1	kW	33.5	
	*1	kcal / h	28,800	
	*1	BTU / h	114,300	
	Power input		kW	7.36
	Current input		A	12.4-11.8-11.3
COP		kW / kW	4.55	
Temp. range of cooling	Indoor	W.B.	15.0 ~ 24.0°C(59 ~ 75°F)	
	Circulating water	°C	10.0 ~ 45.0°C(50 ~ 113°F)	
Heating capacity (Nominal)	*2	kW	37.5	
	*2	kcal / h	32,300	
	*2	BTU / h	128,000	
	Power input		kW	8.15
	Current input		A	13.7-13.0-12.5
COP		kW / kW	4.60	
Temp. range of heating	Indoor	D.B.	15.0 ~ 27.0°C(59 ~ 81°F)	
	Circulating water	°C	10.0 ~ 45.0°C(50 ~ 113°F)	
Indoor unit connectable	Total capacity		50 ~ 130 % of heat source unit capacity	
	Model / Quantity		P15 ~ P250 / 1 ~ 26	
Sound pressure level (measured in anechoic room)		dB <A>	50	
Refrigerant piping diameter	Liquid pipe	mm (in.)	9.52(3/8) Brazed (12.7(1/2) Brazed, total length >= 40m)	
	Gas pipe	mm (in.)	22.2(7/8) Brazed	
Circulating water	Water flow rate	m ³ / h	5.76	
		L / min	96	
		cfm	3.4	
	Pressure drop	kPa	17	
	Operating volume range	m ³ / h	4.5 ~ 7.2	
Compressor	Type x Quantity		Inverter scroll hermetic compressor	
	Manufacture		AC&R Works, MITSUBISHI ELECTRIC CORPORATION	
	Starting method		Inverter	
	Motor output	kW	7.4	
	Case heater	kW	0.035(240 V)	
	Lubricant		MEL32	
External finish		Acrylic painted steel plate		
External dimension HxWxD		mm	1,160(1,100 without legs) x 880 x 550	
		in.	45-11/16(43-5/16 without legs) x 34-11/16 x 21-11/16	
Protection devices	High pressure protection		High pressure sensor, High pressure switch at 4.15MPa (601 psi)	
	Inverter circuit (COMP.)		Over-heat protection, Over-current protection	
	Compressor		Over-heat protection	
Refrigerant	Type x original charge		R410A x 5.0kg (12lbs)	
	Control		Indoor LEV and BC controller	
Net weight		kg (lbs)	195(430)	
Heat exchanger		plate type		
	Water volume in plate	l	5.0	
	Water pressure Max.	MPa	2.0	
HIC circuit (HIC: Heat Inter-Changer)		-		
Drawing	External		KB94T222	
	Wiring		KE94C317	
Standard attachment	Document		Installation Manual	
	Accessory		Refrigerant conn. pipe	
Optional parts		Joint: CMY-Y102S-G2, CMY-Y102L-G2 Header: CMY-Y104/108/1010-G		
Remarks	<ul style="list-style-type: none"> •Details on foundation work, duct work, insulation work, electrical wiring, power source switch, and other items shall be referred to the Installation Manual. •Due to continuing improvement, above specifications may be subject to change without notice. •The ambient temperature of the heat source unit needs to be kept below 40°C D.B. •The ambient relative humidity of the heat source unit needs to be kept below 80%. •The heat source Unit should not be installed at outdoor. •Be sure to mount a strainer (more than 50 meshes) at the water inlet piping of the unit. •Be sure to provide interlocking for the unit operation and water circuit. 			

Notes :	Unit converter
1.Nominal cooling conditions(subject to JIS B8615-1) Indoor:27°CDB/19°CWB(81°FDB/66°FWB), Water temperature:30°C(86°F) Pipe length:7.5m(24-9/16ft.), Level difference:0m(0ft.)	kcal =kW x 860 BTU/h =kW x 3,412
2.Nominal heating conditions(subject to JIS B8615-1) Indoor:20°CDB(68°FDB), Water temperature:20°C(68°F) Pipe length:7.5m(24-9/16ft.), Level difference:0m(0ft.)	cfm =m ³ /min x 35.31 lbs =kg / 0.4536
	*The specification data is subject to rounding variation.

1. SPECIFICATIONS

DATA G8

Model			PQHY-P400YSHM-A			
Power source			3-phase 4-wire 380-400-415V 50/60Hz			
Cooling capacity (Nominal)	*1	kW	45.0			
	*1	kcal / h	38,700			
	*1	BTU / h	153,500			
		Power input	kW	8.25		
		Current input	A	13.9-13.2-12.7		
		COP	kW / kW	5.45		
Temp. range of cooling	Indoor	W.B.	15.0 ~ 24.0°C(59 ~ 75°F)			
	Circulating water	°C	10.0 ~ 45.0°C(50 ~ 113°F)			
Heating capacity (Nominal)	*2	kW	50.0			
	*2	kcal / h	43,000			
	*2	BTU / h	170,600			
		Power input	kW	8.65		
		Current input	A	14.6-13.8-13.3		
		COP	kW / kW	5.78		
Temp. range of heating	Indoor	D.B.	15.0 ~ 27.0°C(59 ~ 81°F)			
	Circulating water	°C	10.0 ~ 45.0°C(50 ~ 113°F)			
Indoor unit connectable	Total capacity		50 ~ 130 % of heat source unit capacity			
	Model / Quantity		P15 ~ P250 / 1 ~ 34			
Sound pressure level (measured in anechoic room)		dB <A>	50			
Refrigerant piping diameter	Liquid pipe	mm (in.)	12.7(1/2) Brazed			
	Gas pipe	mm (in.)	28.58(1-1/8) Brazed			
Set Model						

Model			PQHY-P200YHM-A	PQHY-P200YHM-A
Circulating water	Water flow rate	m ³ / h	5.76 + 5.76	
		L / min	96 + 96	
		cfm	3.4 + 3.4	
	Pressure drop	kPa	17	17
Operating volume range		m ³ / h	4.5 + 4.5 ~ 7.2 + 7.2	
Compressor	Type x Quantity		Inverter scroll hermetic compressor	
	Manufacture		AC&R Works, MITSUBISHI ELECTRIC CORPORATION	
	Starting method		Inverter	
	Motor output	kW	4.6	
	Case heater	kW	0.035(240 V)	
	Lubricant		MEL32	
External finish			Acrylic painted steel plate	
External dimension HxWxD	mm		1,160(1,100 without legs) x 880 x 550	
	in.		45-11/16(43-5/16 without legs) x 34-11/16 x 21-11/16	
Protection devices	High pressure protection		High pressure sensor, High pressure switch at 4.15MPa (601 psi)	
	Inverter circuit (COMP.)		Over-heat protection, Over-current protection	
	Compressor		Over-heat protection	
Refrigerant	Type x original charge		R410A x 5.0kg (12lbs)	
	Control		Indoor LEV and BC controller	
Net weight		kg (lbs)	195(430)	
Heat exchanger			plate type	
	Water volume in plate	l	5.0	
	Water pressure Max.	MPa	2.0	
HIC circuit (HIC: Heat Inter-Changer)			-	
Pipe between unit and distributor	Liquid pipe	mm (in.)	9.52(3/8) Brazed	
	Gas pipe	mm (in.)	19.05(3/4) Brazed	
Drawing	External		KB94T223	
	Wiring		KE94C317	
Standard attachment	Document		Installation Manual	
	Accessory		Refrigerant conn. pipe	
Optional parts			Heat Source Twinning kit: CMY-Y100VBK2 Joint: CMY-Y102S-G2, CMY-Y102L-G2, CMY-Y202-G2 Header: CMY-Y104/108/1010-G	
Remarks			<ul style="list-style-type: none"> •Details on foundation work, duct work, insulation work, electrical wiring, power source switch, and other items shall be referred to the Installation Manual. •Due to continuing improvement, above specifications may be subject to change without notice. •The ambient temperature of the heat source unit needs to be kept below 40°C D.B. •The ambient relative humidity of the heat source unit needs to be kept below 80%. •The heat source Unit should not be installed at outdoor. •Be sure to mount a strainer (more than 50 meshes) at the water inlet piping of the unit. •Be sure to provide interlocking for the unit operation and water circuit. 	

Notes :	1.Nominal cooling conditions(subject to JIS B8615-1) Indoor:27°CDB/19°CWB(81°FDB/66°F WB), Water temperature:30°C(86°F) Pipe length:7.5m(24-9/16ft.), Level difference:0m(0ft.)	Unit converter kcal =kW x 860 BTU/h =kW x 3,412 cfm =m ³ /min x 35.31 lbs =kg / 0.4536
	2.Nominal heating conditions(subject to JIS B8615-1) Indoor:20°CDB(68°FDB), Water temperature:20°C(68°F) Pipe length:7.5m(24-9/16ft.), Level difference:0m(0ft.)	
		*The specification data is subject to rounding variation.

1. SPECIFICATIONS

Model			PQHY-P450YSHM-A	
Power source	3-phase 4-wire 380-400-415V 50/60Hz			
Cooling capacity (Nominal)	*1	kW	50.0	
	*1	kcal / h	43,000	
	*1	BTU / h	170,600	
	Power input	kW	9.84	
	Current input	A	16.6-15.7-15.2	
Temp. range of cooling	COP	kW / kW	5.08	
	Indoor	W.B.	15.0 ~ 24.0°C(59 ~ 75°F)	
	Circulating water	°C	10.0 ~ 45.0°C(50 ~ 113°F)	
Heating capacity (Nominal)	*2	kW	56.0	
	*2	kcal / h	48,200	
	*2	BTU / h	191,100	
	Power input	kW	10.42	
	Current input	A	17.5-16.7-16.1	
Temp. range of heating	COP	kW / kW	5.37	
	Indoor	D.B.	15.0 ~ 27.0°C(59 ~ 81°F)	
	Circulating water	°C	10.0 ~ 45.0°C(50 ~ 113°F)	
Indoor unit connectable	Total capacity	50 ~ 130 % of heat source unit capacity		
	Model / Quantity	P15 ~ P250 / 1 ~ 39		
Sound pressure level (measured in anechoic room)	dB <A>	51		
Refrigerant piping diameter	Liquid pipe	mm (in.)	15.88(5/8) Brazed	
	Gas pipe	mm (in.)	28.58(1-1/8) Brazed	

Model			PQHY-P250YHM-A		PQHY-P200YHM-A	
Circulating water	Water flow rate	m ³ / h	5.76 + 5.76			
		L / min	96 + 96			
		cfm	3.4 + 3.4			
	Pressure drop	kPa	17		17	
Operating volume range	m ³ / h	4.5 + 4.5 ~ 7.2 + 7.2				
Compressor	Type x Quantity		Inverter scroll hermetic compressor		Inverter scroll hermetic compressor	
	Manufacture		AC&R Works, MITSUBISHI ELECTRIC CORPORATION		AC&R Works, MITSUBISHI ELECTRIC CORPORATION	
	Starting method		Inverter		Inverter	
	Motor output	kW	6.3		4.6	
	Case heater	kW	0.035(240 V)		0.035(240 V)	
	Lubricant		MEL32		MEL32	
External finish			Acrylic painted steel plate		Acrylic painted steel plate	
External dimension HxWxD	mm		1,160(1,100 without legs) x 880 x 550		1,160(1,100 without legs) x 880 x 550	
	in.		45-11/16(43-5/16 without legs) x 34-11/16 x 21-11/16		45-11/16(43-5/16 without legs) x 34-11/16 x 21-11/16	
Protection devices	High pressure protection		High pressure sensor, High pressure switch at 4.15MPa (601 psi)		High pressure sensor, High pressure switch at 4.15MPa (601 psi)	
	Inverter circuit (COMP.)		Over-heat protection, Over-current protection		Over-heat protection, Over-current protection	
	Compressor		Over-heat protection		Over-heat protection	
Refrigerant	Type x original charge		R410A x 5.0kg (12lbs)		R410A x 5.0kg (12lbs)	
	Control		Indoor LEV and BC controller			
Net weight	kg (lbs)		195(430)		195(430)	
Heat exchanger			plate type		plate type	
	Water volume in plate	l	5.0		5.0	
	Water pressure Max.	MPa	2.0		2.0	
HIC circuit (HIC: Heat Inter-Changer)			-			
Pipe between unit and distributor	Liquid pipe	mm (in.)	9.52(3/8) Brazed		9.52(3/8) Brazed	
	Gas pipe	mm (in.)	22.2(7/8) Brazed		22.2(7/8) Brazed	
Drawing	External		KB94T223			
	Wiring		KE94C317		KE94C317	
Standard attachment	Document		Installation Manual			
	Accessory		Refrigerant conn. pipe			
Optional parts			Heat Source Twinning kit: CMY-Y100VBK2 Joint: CMY-Y102S-G2, CMY-Y102L-G2, CMY-Y202-G2 Header: CMY-Y104/108/1010-G			
Remarks			<ul style="list-style-type: none"> •Details on foundation work, duct work, insulation work, electrical wiring, power source switch, and other items shall be referred to the Installation Manual. •Due to continuing improvement, above specifications may be subject to change without notice. •The ambient temperature of the heat source unit needs to be kept below 40°C D.B. •The ambient relative humidity of the heat source unit needs to be kept below 80%. •The heat source Unit should not be installed at outdoor. •Be sure to mount a strainer (more than 50 meshes) at the water inlet piping of the unit. •Be sure to provide interlocking for the unit operation and water circuit. 			

Notes :	Unit converter
1.Nominal cooling conditions(subject to JIS B8615-1) Indoor:27°CDB/19°CWB(81°FDB/66°FWB), Water temperature:30°C(86°F) Pipe length:7.5m(24-9/16ft.), Level difference:0m(0ft.)	kcal =kW x 860 BTU/h =kW x 3,412
2.Nominal heating conditions(subject to JIS B8615-1) Indoor:20°CDB(68°FDB), Water temperature:20°C(68°F) Pipe length:7.5m(24-9/16ft.), Level difference:0m(0ft.)	cfm =m ³ /min x 35.31 lbs =kg / 0.4536
	*The specification data is subject to rounding variation.

1. SPECIFICATIONS

DATA G8

Model			PQHY-P500YSHM-A			
Power source			3-phase 4-wire 380-400-415V 50/60Hz			
Cooling capacity (Nominal)	*1	kW	56.0			
	*1	kcal / h	48,200			
	*1	BTU / h	191,100			
		Power input	kW	11.45		
		Current input	A	19.3-18.3-17.6		
		COP	kW / kW	4.89		
Temp. range of cooling	Indoor	W.B.	15.0 ~ 24.0°C(59 ~ 75°F)			
	Circulating water	°C	10.0 ~ 45.0°C(50 ~ 113°F)			
Heating capacity (Nominal)	*2	kW	63.0			
	*2	kcal / h	54,200			
	*2	BTU / h	215,000			
		Power input	kW	12.06		
		Current input	A	20.3-19.3-18.6		
		COP	kW / kW	5.22		
Temp. range of heating	Indoor	D.B.	15.0 ~ 27.0°C(59 ~ 81°F)			
	Circulating water	°C	10.0 ~ 45.0°C(50 ~ 113°F)			
Indoor unit connectable	Total capacity		50 ~ 130 % of heat source unit capacity			
	Model / Quantity		P15 ~ P250 / 1 ~ 43			
Sound pressure level (measured in anechoic room)	dB <A>		52			
Refrigerant piping diameter	Liquid pipe	mm (in.)	15.88(5/8) Brazed			
	Gas pipe	mm (in.)	28.58(1-1/8) Brazed			
Set Model						

Model			PQHY-P250YHM-A			PQHY-P250YHM-A		
Circulating water	Water flow rate	m ³ / h	5.76 + 5.76					
		L / min	96 + 96					
		cfm	3.4 + 3.4					
	Pressure drop	kPa	17			17		
Operating volume range	m ³ / h		4.5 + 4.5 ~ 7.2 + 7.2					
Compressor	Type x Quantity		Inverter scroll hermetic compressor			Inverter scroll hermetic compressor		
	Manufacture		AC&R Works, MITSUBISHI ELECTRIC CORPORATION			AC&R Works, MITSUBISHI ELECTRIC CORPORATION		
	Starting method		Inverter			Inverter		
	Motor output	kW	6.3			6.3		
	Case heater	kW	0.035(240 V)			0.035(240 V)		
	Lubricant		MEL32			MEL32		
External finish			Acrylic painted steel plate			Acrylic painted steel plate		
External dimension HxWxD	mm		1,160(1,100 without legs) x 880 x 550			1,160(1,100 without legs) x 880 x 550		
	in.		45-11/16(43-5/16 without legs) x 34-11/16 x 21-11/16			45-11/16(43-5/16 without legs) x 34-11/16 x 21-11/16		
Protection devices	High pressure protection		High pressure sensor, High pressure switch at 4.15MPa (601 psi)			High pressure sensor, High pressure switch at 4.15MPa (601 psi)		
	Inverter circuit (COMP.)		Over-heat protection, Over-current protection			Over-heat protection, Over-current protection		
	Compressor		Over-heat protection			Over-heat protection		
Refrigerant	Type x original charge		R410A x 5.0kg (12lbs)			R410A x 5.0kg (12lbs)		
	Control		Indoor LEV and BC controller					
Net weight	kg (lbs)		195(430)			195(430)		
Heat exchanger			plate type			plate type		
	Water volume in plate	l	5.0			5.0		
	Water pressure Max.	MPa	2.0			2.0		
HIC circuit (HIC: Heat Inter-Changer)			-			-		
Pipe between unit and distributor	Liquid pipe	mm (in.)	9.52(3/8) Brazed			9.52(3/8) Brazed		
	Gas pipe	mm (in.)	22.2(7/8) Brazed			22.2(7/8) Brazed		
Drawing	External		KB94T223			KB94T223		
	Wiring		KE94C317			KE94C317		
Standard attachment	Document		Installation Manual					
	Accessory		Refrigerant conn. pipe					
Optional parts			Heat Source Twinning kit: CMY-Y100VBK2 Joint: CMY-Y102S-G2, CMY-Y102L-G2, CMY-Y202-G2 Header: CMY-Y104/108/1010-G					
Remarks			<ul style="list-style-type: none"> •Details on foundation work, duct work, insulation work, electrical wiring, power source switch, and other items shall be referred to the Installation Manual. •Due to continuing improvement, above specifications may be subject to change without notice. •The ambient temperature of the heat source unit needs to be kept below 40°C D.B. •The ambient relative humidity of the heat source unit needs to be kept below 80%. •The heat source Unit should not be installed at outdoor. •Be sure to mount a strainer (more than 50 meshes) at the water inlet piping of the unit. •Be sure to provide interlocking for the unit operation and water circuit. 					

Notes :	Unit converter
1.Nominal cooling conditions(subject to JIS B8615-1) Indoor:27°CDB/19°CWB(81°FDB/66°FWB), Water temperature:30°C(86°F) Pipe length:7.5m(24-9/16ft.), Level difference:0m(0ft.)	kcal =kW x 860 BTU/h =kW x 3,412
2.Nominal heating conditions(subject to JIS B8615-1) Indoor:20°CDB(68°FDB), Water temperature:20°C(68°F) Pipe length:7.5m(24-9/16ft.), Level difference:0m(0ft.)	cfm =m ³ /min x 35.31 lbs =kg / 0.4536
	*The specification data is subject to rounding variation.

1. SPECIFICATIONS

Model			PQHY-P550YSHM-A	
Power source	3-phase 4-wire 380-400-415V 50/60Hz			
Cooling capacity (Nominal)	*1	kW	63.0	
	*1	kcal / h	54,200	
	*1	BTU / h	215,000	
	Power input	kW	13.46	
	Current input	A	22.7-21.5-20.8	
Temp. range of cooling	Indoor	W.B.	15.0 ~ 24.0°C(59 ~ 75°F)	
	Circulating water	°C	10.0 ~ 45.0°C(50 ~ 113°F)	
Heating capacity (Nominal)	*2	kW	69.0	
	*2	kcal / h	59,300	
	*2	BTU / h	235,400	
	Power input	kW	14.65	
	Current input	A	24.7-23.4-22.6	
Temp. range of heating	Indoor	D.B.	15.0 ~ 27.0°C(59 ~ 81°F)	
	Circulating water	°C	10.0 ~ 45.0°C(50 ~ 113°F)	
Indoor unit connectable	Total capacity	50 ~ 130 % of heat source unit capacity		
	Model / Quantity	P15 ~ P250 / 2 ~ 47		
Sound pressure level (measured in anechoic room)	dB <A>	52.5		
Refrigerant piping diameter	Liquid pipe	mm (in.)	15.88(5/8) Brazed	
	Gas pipe	mm (in.)	28.58(1-1/8) Brazed	

Model			PQHY-P300YHM-A		PQHY-P250YHM-A	
Circulating water	Water flow rate	m ³ / h	5.76 + 5.76			
		L / min	96 + 96			
		cfm	3.4 + 3.4			
	Pressure drop	kPa	17		17	
Operating volume range	m ³ / h	4.5 + 4.5 ~ 7.2 + 7.2				
Compressor	Type x Quantity		Inverter scroll hermetic compressor		Inverter scroll hermetic compressor	
	Manufacture		AC&R Works, MITSUBISHI ELECTRIC CORPORATION		AC&R Works, MITSUBISHI ELECTRIC CORPORATION	
	Starting method		Inverter		Inverter	
	Mo-r output	kW	7.4		6.3	
	Case heater	kW	0.035(240 V)		0.035(240 V)	
Lubricant		MEL32		MEL32		
External finish			Acrylic painted steel plate		Acrylic painted steel plate	
External dimension HxWxD		mm	1,160(1,100 without legs) x 880 x 550		1,160(1,100 without legs) x 880 x 550	
		in.	45-11/16(43-5/16 without legs) x 34-11/16 x 21-11/16		45-11/16(43-5/16 without legs) x 34-11/16 x 21-11/16	
Protection devices	High pressure protection		High pressure sensor, High pressure switch at 4.15MPa (601 psi)		High pressure sensor, High pressure switch at 4.15MPa (601 psi)	
	Inverter circuit (COMP.)		Over-heat protection, Over-current protection		Over-heat protection, Over-current protection	
	Compressor		Over-heat protection		Over-heat protection	
Refrigerant	Type x original charge		R410A x 5.0kg (12lbs)		R410A x 5.0kg (12lbs)	
	Control		Indoor LEV and BC controller			
Net weight		kg (lbs)	195(430)		195(430)	
Heat exchanger			plate type		plate type	
	Water volume in plate	l	5.0		5.0	
	Water pressure Max.	MPa	2.0		2.0	
HIC circuit (HIC: Heat Inter-Changer)			-		-	
Pipe between unit and distribu-r	Liquid pipe	mm (in.)	12.7(1/2) Brazed		12.7(1/2) Brazed	
	Gas pipe	mm (in.)	22.2(7/8) Brazed		22.2(7/8) Brazed	
Drawing	External		KB94T223			
	Wiring		KE94C317		KE94C317	
Standard attachment	Document		Installation Manual			
	Accessory		Refrigerant conn. pipe			
Optional parts			Heat Source Twinning kit: CMY-Y100VBK2 Joint: CMY-Y102S-G2, CMY-Y102L-G2, CMY-Y202-G2, CMY-Y302-G2 Header: CMY-Y104/108/1010-G			
Remarks			<ul style="list-style-type: none"> • Details on foundation work, duct work, insulation work, electrical wiring, power source switch, and other items shall be referred to the Installation Manual. • Due to continuing improvement, above specifications may be subject to change without notice. • The ambient temperature of the heat source unit needs to be kept below 40°C D.B. • The ambient relative humidity of the heat source unit needs to be kept below 80%. • The heat source Unit should not be installed at outdoor. • Be sure to mount a strainer (more than 50 meshes) at the water inlet piping of the unit. • Be sure to provide interlocking for the unit operation and water circuit. 			

Notes :	Unit converter
1.Nominal cooling conditions(subject to JIS B8615-1) Indoor:27°CDB/19°CWB(81°FDB/66°FWB), Water temperature:30°C(86°F) Pipe length:7.5m(24-9/16ft.), Level difference:0m(0ft.)	kcal =kW x 860 BTU/h =kW x 3,412
2.Nominal heating conditions(subject to JIS B8615-1) Indoor:20°CDB(68°FDB), Water temperature:20°C(68°F) Pipe length:7.5m(24-9/16ft.), Level difference:0m(0ft.)	cfm =m ³ /min x 35.31 lbs =kg / 0.4536
	*The specification data is subject to rounding variation.

1. SPECIFICATIONS

DATA G8

Model			PQHY-P600YSHM-A			
Power source			3-phase 4-wire 380-400-415V 50/60Hz			
Cooling capacity (Nominal)	*1	kW	69.0			
	*1	kcal / h	59,300			
	*1	BTU / h	235,400			
	Power input		kW	15.48		
	Current input		A	26.1-24.8-23.9		
COP		kW / kW	4.45			
Temp. range of cooling	Indoor	W.B.	15.0 ~ 24.0°C(59 ~ 75°F)			
	Circulating water	°C	10.0 ~ 45.0°C(50 ~ 113°F)			
Heating capacity (Nominal)	*2	kW	76.5			
	*2	kcal / h	65,800			
	*2	BTU / h	261,000			
	Power input		kW	17.12		
	Current input		A	28.9-27.4-26.4		
COP		kW / kW	4.46			
Temp. range of heating	Indoor	D.B.	15.0 ~ 27.0°C(59 ~ 81°F)			
	Circulating water	°C	10.0 ~ 45.0°C(50 ~ 113°F)			
Indoor unit connectable	Total capacity		50 ~ 130 % of heat source unit capacity			
Set Model		Model / Quantity	P15 ~ P250 / 2 ~ 50			
Sound pressure level (measured in anechoic room)		dB <A>	53			
Refrigerant piping diameter	Liquid pipe	mm (in.)	15.88(5/8) Brazed			
	Gas pipe	mm (in.)	28.58(1-1/8) Brazed			

Model			PQHY-P300YHM-A		PQHY-P300YHM-A	
Circulating water	Water flow rate	m ³ / h	5.76 + 5.76			
		L / min	96 + 96			
		cfm	3.4 + 3.4			
	Pressure drop	kPa	17		17	
Operating volume range		m ³ / h	4.5 + 4.5 ~ 7.2 + 7.2			
Compressor	Type x Quantity		Inverter scroll hermetic compressor		Inverter scroll hermetic compressor	
	Manufacture		AC&R Works, MITSUBISHI ELECTRIC CORPORATION		AC&R Works, MITSUBISHI ELECTRIC CORPORATION	
	Starting method		Inverter		Inverter	
	Motor output	kW	7.4		7.4	
	Case heater	kW	0.035(240 V)		0.035(240 V)	
	Lubricant		MEL32		MEL32	
External finish			Acrylic painted steel plate		Acrylic painted steel plate	
External dimension HxWxD		mm	1,160(1,100 without legs) x 880 x 550		1,160(1,100 without legs) x 880 x 550	
		in.	45-11/16(43-5/16 without legs) x 34-11/16 x 21-11/16		45-11/16(43-5/16 without legs) x 34-11/16 x 21-11/16	
Protection devices	High pressure protection		High pressure sensor, High pressure switch at 4.15MPa (601 psi)		High pressure sensor, High pressure switch at 4.15MPa (601 psi)	
	Inverter circuit (COMP.)		Over-heat protection, Over-current protection		Over-heat protection, Over-current protection	
	Compressor		Over-heat protection		Over-heat protection	
Refrigerant	Type x original charge		R410A x 5.0kg (12lbs)		R410A x 5.0kg (12lbs)	
	Control		Indoor LEV and BC controller			
Net weight		kg (lbs)	195(430)		195(430)	
Heat exchanger			plate type		plate type	
	Water volume in plate	l	5.0		5.0	
	Water pressure Max.	MPa	2.0		2.0	
HIC circuit (HIC: Heat Inter-Changer)			-		-	
Pipe between unit and distributor	Liquid pipe	mm (in.)	12.7(1/2) Brazed		12.7(1/2) Brazed	
	Gas pipe	mm (in.)	22.2(7/8) Brazed		22.2(7/8) Brazed	
Drawing	External		KB94T223			
	Wiring		KE94C317		KE94C317	
Standard attachment	Document		Installation Manual			
	Accessory		Refrigerant conn. pipe			
Optional parts			Heat Source Twinning kit: CMY-Y100VBK2 Joint: CMY-Y102S-G2, CMY-Y102L-G2, CMY-Y202-G2, CMY-Y302-G2 Header: CMY-Y104/108/1010-G			
Remarks			<ul style="list-style-type: none"> •Details on foundation work, duct work, insulation work, electrical wiring, power source switch, and other items shall be referred to the Installation Manual. •Due to continuing improvement, above specifications may be subject to change without notice. •The ambient temperature of the heat source unit needs to be kept below 40°C D.B. •The ambient relative humidity of the heat source unit needs to be kept below 80%. •The heat source Unit should not be installed at outdoor. •Be sure to mount a strainer (more than 50 meshes) at the water inlet piping of the unit. •Be sure to provide interlocking for the unit operation and water circuit. 			

Notes :	Unit converter
1.Nominal cooling conditions(subject to JIS B8615-1) Indoor:27°CDB/19°CWB(81°FDB/66°FWB), Water temperature:30°C(86°F) Pipe length:7.5m(24-9/16ft.), Level difference:0m(0ft.)	kcal =kW x 860 BTU/h =kW x 3,412
2.Nominal heating conditions(subject to JIS B8615-1) Indoor:20°CDB(68°FDB), Water temperature:20°C(68°F) Pipe length:7.5m(24-9/16ft.), Level difference:0m(0ft.)	cfm =m ³ /min x 35.31 lbs =kg / 0.4536
	*The specification data is subject to rounding variation.

1. SPECIFICATIONS

Model		PQHY-P650YSHM-A	
Power source		3-phase 4-wire 380-400-415V 50/60Hz	
Cooling capacity (Nominal)	*1 kW	73.0	
	*1 kcal / h	62,800	
	*1 BTU / h	249,100	
	Power input	kW	13.96
	Current input	A	23.5-22.3-21.5
	COP	kW / kW	5.22
Temp. range of cooling	Indoor	W.B.	15.0 ~ 24.0°C(59 ~ 75°F)
	Circulating water	°C	10.0 ~ 45.0°C(50 ~ 113°F)
Heating capacity (Nominal)	*2 kW	81.5	
	*2 kcal / h	70,100	
	*2 BTU / h	278,100	
	Power input	kW	14.74
	Current input	A	24.8-23.6-22.7
	COP	kW / kW	5.52
Temp. range of heating	Indoor	D.B.	15.0 ~ 27.0°C(59 ~ 81°F)
	Circulating water	°C	10.0 ~ 45.0°C(50 ~ 113°F)
Indoor unit connectable	Total capacity	50 ~ 130 % of heat source unit capacity	
	Model / Quantity	P15 ~ P250 / 2 ~ 50	
Sound pressure level (measured in anechoic room)		dB <A> 53	
Refrigerant piping diameter	Liquid pipe	mm (in.)	19.05(3/4) Brazed
	Gas pipe	mm (in.)	34.93(1-3/8) Brazed

Set Model			PQHY-P250YHM-A	PQHY-P200YHM-A	PQHY-P200YHM-A
Circulating water	Water flow rate	m ³ / h	5.76 + 5.76 + 5.76		
		L / min	96 + 96 + 96		
		cfm	3.4 + 3.4 + 3.4		
	Pressure drop	kPa	17	17	17
Operating volume range	m ³ / h	4.5 + 4.5 + 4.5 ~ 7.2 + 7.2 + 7.2			
Compressor	Type x Quantity	Inverter scroll hermetic compressor		Inverter scroll hermetic compressor	Inverter scroll hermetic compressor
	Manufacture	AC&R Works, MITSUBISHI ELECTRIC CORPORATION		AC&R Works, MITSUBISHI ELECTRIC CORPORATION	AC&R Works, MITSUBISHI ELECTRIC CORPORATION
	Starting method	Inverter		Inverter	Inverter
	Motor output	kW	6.3	4.6	4.6
	Case heater	kW	0.035(240 V)	0.035(240 V)	0.035(240 V)
	Lubricant	MEL32		MEL32	MEL32
External finish	Acrylic painted steel plate		Acrylic painted steel plate	Acrylic painted steel plate	
External dimension HxWxD	mm	1,160(1,100 without legs) x 880 x 550	1,160(1,100 without legs) x 880 x 550	1,160(1,100 without legs) x 880 x 550	
		45-11/16(43-5/16 without legs) x 34-11/16 x 21-11/16	45-11/16(43-5/16 without legs) x 34-11/16 x 21-11/16	45-11/16(43-5/16 without legs) x 34-11/16 x 21-11/16	
Protection devices	High pressure protection	High pressure sensor, High pressure switch at 4.15MPa (601 psi)		High pressure sensor, High pressure switch at 4.15MPa (601 psi)	High pressure sensor, High pressure switch at 4.15MPa (601 psi)
	Inverter circuit (COMP.)	Over-heat protection, Over-current protection		Over-heat protection, Over-current protection	Over-heat protection, Over-current protection
	Compressor	Over-heat protection		Over-heat protection	Over-heat protection
Refrigerant	Type x original charge	R410A x 5.0kg (12lbs)		R410A x 5.0kg (12lbs)	R410A x 5.0kg (12lbs)
	Control	LEV and HIC circuit			
Net weight	kg (lbs)	195(430)		195(430)	195(430)
Heat exchanger		plate type		plate type	plate type
	Water volume in plate	l	5.0	5.0	5.0
	Water pressure Max.	MPa	2.0	2.0	2.0
HIC circuit (HIC: Heat Inter-Changer)	Copper pipe,tube-in-tube structure		Copper pipe,tube-in-tube structure	Copper pipe,tube-in-tube structure	
Pipe between unit and distributor	Liquid pipe	mm (in.)	12.7(1/2) Brazed	12.7(1/2) Brazed	12.7(1/2) Brazed
	Gas pipe	mm (in.)	22.2(7/8) Brazed	19.05(3/4) Brazed	19.05(3/4) Brazed
Drawing	External	KB94T659			
	Wiring	KE94C317	KE94C317	KE94C317	
Standard attachment	Document	Installation Manual			
	Accessory	Refrigerant conn. pipe			
Optional parts	Heat Source Twinning kit: CMY-Y300VBK2 Joint: CMY-Y102S-G2,CMY-Y102L-G2,CMY-Y202-G2,CMY-Y302-G2 Header: CMY-Y104/108/1010-G				
Remarks	<ul style="list-style-type: none"> * Details on foundation work, duct work, insulation work, electrical wiring, power source switch, and other items shall be referred to the Installation Manual. * Due to continuing improvement, above specifications may be subject to change without notice. * The ambient temperature of the heat source unit needs to be kept below 40°C D.B. * The ambient relative humidity of the heat source unit needs to be kept below 80%. * The heat source unit should not be installed at outdoor. * Be sure to mount a strainer (more than 50 meshes) at the water inlet piping of the unit. * Be sure to provide interlocking for the unit operation and water circuit. 				

Notes :	Unit converter
1.Nominal cooling conditions(subject to JIS B8615-1) Indoor:27°CDB/19°CWB(81°FDB/66°FWB), Water temperature:30°C(86°F) Pipe length:7.5m(24-9/16ft.), Level difference:0m(0ft.)	kcal =kW x 860 BTU/h =kW x 3,412
2.Nominal heating conditions(subject to JIS B8615-1) Indoor:20°CDB(68°FDB), Water temperature:20°C(68°F) Pipe length:7.5m(24-9/16ft.), Level difference:0m(0ft.)	cfm =m ³ /min x 35.31 lb =kg / 0.4536
	*Above specification data is subject to rounding variation.

1. SPECIFICATIONS

DATA G8

Model			PQHY-P700YSHM-A		
Power source			3-phase 4-wire 380-400-415V 50/60Hz		
Cooling capacity (Nominal)	*1	kW	80.0		
	*1	kcal / h	68,800		
	*1	BTU / h	273,000		
		Power input	kW		
		Current input	A		
	COP	kW / kW			
		5.13			
Temp. range of cooling	Indoor	W.B.	15.0 ~ 24.0°C(59 ~ 75°F)		
	Circulating water	°C	10.0 ~ 45.0°C(50 ~ 113°F)		
Heating capacity (Nominal)	*2	kW	88.0		
	*2	kcal / h	75,700		
	*2	BTU / h	300,300		
		Power input	kW		
		Current input	A		
	COP	kW / kW			
		5.33			
Temp. range of heating	Indoor	D.B.	15.0 ~ 27.0°C(59 ~ 81°F)		
	Circulating water	°C	10.0 ~ 45.0°C(50 ~ 113°F)		
Indoor unit connectable	Total capacity	50 ~ 130 % of heat source unit capacity			
	Model / Quantity	P15 ~ P250 / 2 ~ 50			
Sound pressure level (measured in anechoic room)			dB <A>		
			53.5		
Refrigerant piping diameter	Liquid pipe	mm (in.)	19.05(3/4) Brazed		
	Gas pipe	mm (in.)	34.93(1-3/8) Brazed		

Set Model								
Model			PQHY-P250YHM-A		PQHY-P250YHM-A		PQHY-P200YHM-A	
Circulating water	Water flow rate	m ³ / h	5.76 + 5.76 + 5.76					
		L / min	96 + 96 + 96					
		cfm	3.4 + 3.4 + 3.4					
	Pressure drop	kPa	17		17		17	
Operating volume range	m ³ / h	4.5 + 4.5 + 4.5 ~ 7.2 + 7.2 + 7.2						
Compressor	Type x Quantity		Inverter scroll hermetic compressor		Inverter scroll hermetic compressor		Inverter scroll hermetic compressor	
	Manufacture		AC&R Works, MITSUBISHI ELECTRIC CORPORATION		AC&R Works, MITSUBISHI ELECTRIC CORPORATION		AC&R Works, MITSUBISHI ELECTRIC CORPORATION	
	Starting method		Inverter		Inverter		Inverter	
	Motor output	kW	6.3		6.3		4.6	
	Case heater	kW	0.035(240 V)		0.035(240 V)		0.035(240 V)	
	Lubricant		MEL32		MEL32		MEL32	
External finish			Acrylic painted steel plate		Acrylic painted steel plate		Acrylic painted steel plate	
External dimension HxWxD	mm		1,160(1,100 without legs) x 880 x 550		1,160(1,100 without legs) x 880 x 550		1,160(1,100 without legs) x 880 x 550	
		in.	45-11/16(43-5/16 without legs) x 34-11/16 x 21-11/16		45-11/16(43-5/16 without legs) x 34-11/16 x 21-11/16		45-11/16(43-5/16 without legs) x 34-11/16 x 21-11/16	
Protection devices	High pressure protection		High pressure sensor, High pressure switch at 4.15MPa (601 psi)		High pressure sensor, High pressure switch at 4.15MPa (601 psi)		High pressure sensor, High pressure switch at 4.15MPa (601 psi)	
	Inverter circuit (COMP.)		Over-heat protection, Over-current protection		Over-heat protection, Over-current protection		Over-heat protection, Over-current protection	
	Compressor		Over-heat protection		Over-heat protection		Over-heat protection	
Refrigerant	Type x original charge		R410A x 5.0kg (12lbs)		R410A x 5.0kg (12lbs)		R410A x 5.0kg (12lbs)	
	Control		LEV and HIC circuit					
Net weight			kg (lbs)		195(430)		195(430)	
Heat exchanger			plate type		plate type		plate type	
	Water volume in plate	l	5.0		5.0		5.0	
	Water pressure Max.	MPa	2.0		2.0		2.0	
HIC circuit (HIC: Heat Inter-Changer)			Copper pipe,tube-in-tube structure		Copper pipe,tube-in-tube structure		Copper pipe,tube-in-tube structure	
Pipe between unit and distributor	Liquid pipe	mm (in.)	12.7(1/2) Brazed		12.7(1/2) Brazed		12.7(1/2) Brazed	
	Gas pipe	mm (in.)	22.2(7/8) Brazed		22.2(7/8) Brazed		19.05(3/4) Brazed	
Drawing	External		KB94T659		KB94T659		KB94T659	
	Wiring		KE94C317		KE94C317		KE94C317	
Standard attachment	Document		Installation Manual					
	Accessory		Refrigerant conn. pipe					
Optional parts			Heat Source Twinning kit: CMY-Y300VBK2 Joint: CMY-Y102S-G2,CMY-Y102L-G2,CMY-Y202-G2,CMY-Y302-G2 Header: CMY-Y104/108/1010-G					
Remarks			<p>* Details on foundation work, duct work, insulation work, electrical wiring, power source switch, and other items shall be referred to the Installation Manual.</p> <p>* Due to continuing improvement, above specifications may be subject to change without notice.</p> <p>* The ambient temperature of the heat source unit needs to be kept below 40°C D.B.</p> <p>* The ambient relative humidity of the heat source unit needs to be kept below 80%.</p> <p>* The heat source unit should not be installed at outdoor.</p> <p>* Be sure to mount a strainer (more than 50 meshes) at the water inlet piping of the unit.</p> <p>* Be sure to provide interlocking for the unit operation and water circuit.</p>					

Notes :		Unit converter	
1.Nominal cooling conditions(subject to JIS B8615-1) Indoor:27°CDB/19°CWB(81°FDB/66°FWB), Water temperature:30°C(86°F) Pipe length:7.5m(24-9/16ft.), Level difference:0m(0ft.)		kcal	=kW x 860
2.Nominal heating conditions(subject to JIS B8615-1) Indoor:20°CDB(68°FDB), Water temperature:20°C(68°F) Pipe length:7.5m(24-9/16ft.), Level difference:0m(0ft.)		BTU/h	=kW x 3,412
		cfm	=m ³ /min x 35.31
		lb	=kg / 0.4536
*Above specification data is subject to rounding variation.			

1. SPECIFICATIONS

Model		PQHY-P750YSHM-A	
Power source		3-phase 4-wire 380-400-415V 50/60Hz	
Cooling capacity (Nominal)	*1 kW	85.0	
	*1 kcal / h	73,100	
	*1 BTU / h	290,000	
	Power input	kW	17.19
	Current input	A	29.0-27.5-26.5
	COP	kW / kW	4.94
Temp. range of cooling	Indoor	W.B.	15.0 ~ 24.0°C(59 ~ 75°F)
	Circulating water	°C	10.0 ~ 45.0°C(50 ~ 113°F)
Heating capacity (Nominal)	*2 kW	95.0	
	*2 kcal / h	81,700	
	*2 BTU / h	324,100	
	Power input	kW	18.27
	Current input	A	30.8-29.3-28.2
	COP	kW / kW	5.19
Temp. range of heating	Indoor	D.B.	15.0 ~ 27.0°C(59 ~ 81°F)
	Circulating water	°C	10.0 ~ 45.0°C(50 ~ 113°F)
Indoor unit connectable	Total capacity	50 ~ 130 % of heat source unit capacity	
	Model / Quantity	P15 ~ P250 / 2 ~ 50	
Sound pressure level (measured in anechoic room)		dB <A>	
Refrigerant	Liquid pipe	mm (in.)	19.05(3/4) Brazed
piping diameter	Gas pipe	mm (in.)	34.93(1-3/8) Brazed

Set Model			PQHY-P250YHM-A	PQHY-P250YHM-A	PQHY-P250YHM-A
Circulating water	Water flow rate	m ³ / h	5.76 + 5.76 + 5.76		
		L / min	96 + 96 + 96		
		cfm	3.4 + 3.4 + 3.4		
	Pressure drop	kPa	17	17	17
Operating volume range	m ³ / h	4.5 + 4.5 + 4.5 ~ 7.2 + 7.2 + 7.2			
Compressor	Type x Quantity		Inverter scroll hermetic compressor	Inverter scroll hermetic compressor	Inverter scroll hermetic compressor
	Manufacture		AC&R Works, MITSUBISHI ELECTRIC CORPORATION	AC&R Works, MITSUBISHI ELECTRIC CORPORATION	AC&R Works, MITSUBISHI ELECTRIC CORPORATION
	Starting method		Inverter	Inverter	Inverter
	Motor output	kW	6.3	6.3	6.3
	Case heater	kW	0.035(240 V)	0.035(240 V)	0.035(240 V)
	Lubricant		MEL32	MEL32	MEL32
External finish			Acrylic painted steel plate	Acrylic painted steel plate	Acrylic painted steel plate
External dimension HxWxD	mm		1,160(1,100 without legs) x 880 x 550	1,160(1,100 without legs) x 880 x 550	1,160(1,100 without legs) x 880 x 550
	in.		45-11/16(43-5/16 without legs) x 34-11/16 x 21-11/16	45-11/16(43-5/16 without legs) x 34-11/16 x 21-11/16	45-11/16(43-5/16 without legs) x 34-11/16 x 21-11/16
Protection devices	High pressure protection		High pressure sensor, High pressure switch at 4.15MPa (601 psi)	High pressure sensor, High pressure switch at 4.15MPa (601 psi)	High pressure sensor, High pressure switch at 4.15MPa (601 psi)
	Inverter circuit (COMP.)		Over-heat protection, Over-current protection	Over-heat protection, Over-current protection	Over-heat protection, Over-current protection
	Compressor		Over-heat protection	Over-heat protection	Over-heat protection
Refrigerant	Type x original charge		R410A x 5.0kg (12lbs)	R410A x 5.0kg (12lbs)	R410A x 5.0kg (12lbs)
	Control		LEV and HIC circuit		
Net weight	kg (lbs)		195(430)	195(430)	195(430)
	Heat exchanger		plate type	plate type	plate type
	Water volume in plate	l	5.0	5.0	5.0
	Water pressure Max.	MPa	2.0	2.0	2.0
HIC circuit (HIC: Heat Inter-Changer)			Copper pipe,tube-in-tube structure	Copper pipe,tube-in-tube structure	Copper pipe,tube-in-tube structure
Pipe between unit and distributor	Liquid pipe	mm (in.)	12.7(1/2) Brazed	12.7(1/2) Brazed	12.7(1/2) Brazed
	Gas pipe	mm (in.)	22.2(7/8) Brazed	22.2(7/8) Brazed	22.2(7/8) Brazed
Drawing	External		KB94T659		
	Wiring		KE94C317	KE94C317	KE94C317
Standard attachment	Document		Installation Manual		
	Accessory		Refrigerant conn. pipe		
Optional parts			Heat Source Twinning kit: CMY-Y300VBK2 Joint: CMY-Y102S-G2,CMY-Y102L-G2,CMY-Y202-G2,CMY-Y302-G2 Header: CMY-Y104/108/1010-G		
Remarks			<ul style="list-style-type: none"> * Details on foundation work, duct work, insulation work, electrical wiring, power source switch, and other items shall be referred to the Installation Manual. * Due to continuing improvement, above specifications may be subject to change without notice. * The ambient temperature of the heat source unit needs to be kept below 40°C D.B. * The ambient relative humidity of the heat source unit needs to be kept below 80%. * The heat source unit should not be installed at outdoor. * Be sure to mount a strainer (more than 50 meshes) at the water inlet piping of the unit. * Be sure to provide interlocking for the unit operation and water circuit. 		

Notes :	Unit converter
1.Nominal cooling conditions(subject to JIS B8615-1) Indoor:27°CDB/19°CWB(81°FDB/66°FWB), Water temperature:30°C(86°F) Pipe length:7.5m(24-9/16ft.), Level difference:0m(0ft.)	kcal =kW x 860 BTU/h =kW x 3,412
2.Nominal heating conditions(subject to JIS B8615-1) Indoor:20°CDB(68°FDB), Water temperature:20°C(68°F) Pipe length:7.5m(24-9/16ft.), Level difference:0m(0ft.)	cfm =m ³ /min x 35.31 lb =kg / 0.4536
	*Above specification data is subject to rounding variation.

1. SPECIFICATIONS

DATA G8

Model			PQHY-P800YSHM-A			
Power source			3-phase 4-wire 380-400-415V 50/60Hz			
Cooling capacity (Nominal)	*1	kW	90.0			
	*1	kcal / h	77,400			
	*1	BTU / h	307,100			
		Power input	kW	19.18		
		Current input	A	32.3-30.7-29.6		
	COP	kW / kW	4.69			
Temp. range of cooling	Indoor	W.B.	15.0 ~ 24.0°C(59 ~ 75°F)			
	Circulating water	°C	10.0 ~ 45.0°C(50 ~ 113°F)			
Heating capacity (Nominal)	*2	kW	100.0			
	*2	kcal / h	86,000			
	*2	BTU / h	341,200			
		Power input	kW	20.74		
		Current input	A	35.0-33.2-32.0		
	COP	kW / kW	4.82			
Temp. range of heating	Indoor	D.B.	15.0 ~ 27.0°C(59 ~ 81°F)			
	Circulating water	°C	10.0 ~ 45.0°C(50 ~ 113°F)			
Indoor unit connectable	Total capacity		50 ~ 130 % of heat source unit capacity			
	Model / Quantity		P15 ~ P250 / 2 ~ 50			
Sound pressure level (measured in anechoic room)		dB <A>	54			
Refrigerant piping diameter	Liquid pipe	mm (in.)	19.05(3/4) Brazed			
	Gas pipe	mm (in.)	34.93(1-3/8) Brazed			

Set Model			PQHY-P300YHM-A			PQHY-P250YHM-A			PQHY-P250YHM-A		
Circulating water	Water flow rate	m ³ / h	5.76 + 5.76 + 5.76								
		L / min	96 + 96 + 96								
		cfm	3.4 + 3.4 + 3.4								
	Pressure drop	kPa	17			17			17		
	Operating volume range	m ³ / h	4.5 + 4.5 + 4.5 ~ 7.2 + 7.2 + 7.2								
Compressor	Type x Quantity		Inverter scroll hermetic compressor			Inverter scroll hermetic compressor			Inverter scroll hermetic compressor		
	Manufacture		AC&R Works, MITSUBISHI ELECTRIC CORPORATION			AC&R Works, MITSUBISHI ELECTRIC CORPORATION			AC&R Works, MITSUBISHI ELECTRIC CORPORATION		
	Starting method		Inverter			Inverter			Inverter		
	Motor output	kW	7.4			6.3			6.3		
	Case heater	kW	0.035(240 V)			0.035(240 V)			0.035(240 V)		
	Lubricant		MEL32			MEL32			MEL32		
External finish			Acrylic painted steel plate			Acrylic painted steel plate			Acrylic painted steel plate		
External dimension HxWxD		mm	1,160(1,100 without legs) x 880 x 550			1,160(1,100 without legs) x 880 x 550			1,160(1,100 without legs) x 880 x 550		
		in.	45-11/16(43-5/16 without legs) x 34-11/16 x 21-11/16			45-11/16(43-5/16 without legs) x 34-11/16 x 21-11/16			45-11/16(43-5/16 without legs) x 34-11/16 x 21-11/16		
Protection devices	High pressure protection		High pressure sensor, High pressure switch at 4.15MPa (601 psi)			High pressure sensor, High pressure switch at 4.15MPa (601 psi)			High pressure sensor, High pressure switch at 4.15MPa (601 psi)		
	Inverter circuit (COMP.)		Over-heat protection, Over-current protection			Over-heat protection, Over-current protection			Over-heat protection, Over-current protection		
	Compressor		Over-heat protection			Over-heat protection			Over-heat protection		
Refrigerant	Type x original charge		R410A x 5.0kg (12lbs)			R410A x 5.0kg (12lbs)			R410A x 5.0kg (12lbs)		
	Control		LEV and HIC circuit								
Net weight		kg (lbs)	195(430)			195(430)			195(430)		
Heat exchanger			plate type			plate type			plate type		
	Water volume in plate	l	5.0			5.0			5.0		
	Water pressure Max.	MPa	2.0			2.0			2.0		
HIC circuit (HIC: Heat Inter-Changer)			Copper pipe,tube-in-tube structure			Copper pipe,tube-in-tube structure			Copper pipe,tube-in-tube structure		
Pipe between unit and distributor	Liquid pipe	mm (in.)	12.7(1/2) Brazed			12.7(1/2) Brazed			12.7(1/2) Brazed		
	Gas pipe	mm (in.)	22.2(7/8) Brazed			22.2(7/8) Brazed			22.2(7/8) Brazed		
Drawing	External		KB94T659			KB94T659			KB94T659		
	Wiring		KE94C317			KE94C317			KE94C317		
Standard attachment	Document		Installation Manual								
	Accessory		Refrigerant conn. pipe								
Optional parts			Heat Source Twinning kit: CMY-Y300VBK2 Joint: CMY-Y102S-G2,CMY-Y102L-G2,CMY-Y202-G2,CMY-Y302-G2 Header: CMY-Y104/108/1010-G								
Remarks			<p>* Details on foundation work, duct work, insulation work, electrical wiring, power source switch, and other items shall be referred to the Installation Manual.</p> <p>* Due to continuing improvement, above specifications may be subject to change without notice.</p> <p>* The ambient temperature of the heat source unit needs to be kept below 40°C D.B.</p> <p>* The ambient relative humidity of the heat source unit needs to be kept below 80%.</p> <p>* The heat source unit should not be installed at outdoor.</p> <p>* Be sure to mount a strainer (more than 50 meshes) at the water inlet piping of the unit.</p> <p>* Be sure to provide interlocking for the unit operation and water circuit.</p>								

Notes :	Unit converter
1.Nominal cooling conditions(subject to JIS B8615-1) Indoor:27°CDB/19°CWB(81°FDB/66°FWB), Water temperature:30°C(86°F) Pipe length:7.5m(24-9/16ft.), Level difference:0m(0ft.)	kcal =kW x 860 BTU/h =kW x 3,412
2.Nominal heating conditions(subject to JIS B8615-1) Indoor:20°CDB(68°FDB), Water temperature:20°C(68°F) Pipe length:7.5m(24-9/16ft.), Level difference:0m(0ft.)	cfm =m ³ /min x 35.31 lb =kg / 0.4536
	*Above specification data is subject to rounding variation.

1. SPECIFICATIONS

Model		PQHY-P850YSHM-A	
Power source		3-phase 4-wire 380-400-415V 50/60Hz	
Cooling capacity (Nominal)	*1 kW	96.0	
	*1 kcal / h	82,600	
	*1 BTU / h	327,600	
	Power input	kW	21.20
	Current input	A	35.7-33.9-32.7
	COP	kW / kW	4.52
Temp. range of cooling	Indoor	W.B.	15.0 ~ 24.0°C(59 ~ 75°F)
	Circulating water	°C	10.0 ~ 45.0°C(50 ~ 113°F)
Heating capacity (Nominal)	*2 kW	108.0	
	*2 kcal / h	92,900	
	*2 BTU / h	368,500	
	Power input	kW	23.21
	Current input	A	39.1-37.2-35.8
	COP	kW / kW	4.65
Temp. range of heating	Indoor	D.B.	15.0 ~ 27.0°C(59 ~ 81°F)
	Circulating water	°C	10.0 ~ 45.0°C(50 ~ 113°F)
Indoor unit connectable	Total capacity	50 ~ 130 % of heat source unit capacity	
	Model / Quantity	P15 ~ P250 / 2 ~ 50	
Sound pressure level (measured in anechoic room)		dB <A> 54.5	
Refrigerant piping diameter	Liquid pipe	mm (in.)	19.05(3/4) Brazed
	Gas pipe	mm (in.)	41.28(1-5/8) Brazed

Set Model			PQHY-P300YHM-A	PQHY-P300YHM-A	PQHY-P250YHM-A
Circulating water	Water flow rate	m ³ / h	5.76 + 5.76 + 5.76		
		L / min	96 + 96 + 96		
		cfm	3.4 + 3.4 + 3.4		
	Pressure drop	kPa	17	17	17
Operating volume range	m ³ / h	4.5 + 4.5 + 4.5 ~ 7.2 + 7.2 + 7.2			
Compressor	Type x Quantity		Inverter scroll hermetic compressor	Inverter scroll hermetic compressor	Inverter scroll hermetic compressor
	Manufacture		AC&R Works, MITSUBISHI ELECTRIC CORPORATION	AC&R Works, MITSUBISHI ELECTRIC CORPORATION	AC&R Works, MITSUBISHI ELECTRIC CORPORATION
	Starting method		Inverter	Inverter	Inverter
	Motor output	kW	7.4	7.4	6.3
	Case heater	kW	0.035(240 V)	0.035(240 V)	0.035(240 V)
	Lubricant		MEL32	MEL32	MEL32
External finish			Acrylic painted steel plate	Acrylic painted steel plate	Acrylic painted steel plate
External dimension HxWxD			mm 1,160(1,100 without legs) x 880 x 550 45-11/16(43-5/16 without legs) x 34-11/16 x 21-11/16	mm 1,160(1,100 without legs) x 880 x 550 45-11/16(43-5/16 without legs) x 34-11/16 x 21-11/16	mm 1,160(1,100 without legs) x 880 x 550 45-11/16(43-5/16 without legs) x 34-11/16 x 21-11/16
Protection devices	High pressure protection		High pressure sensor, High pressure switch at 4.15MPa (601 psi)	High pressure sensor, High pressure switch at 4.15MPa (601 psi)	High pressure sensor, High pressure switch at 4.15MPa (601 psi)
	Inverter circuit (COMP.)		Over-heat protection, Over-current protection	Over-heat protection, Over-current protection	Over-heat protection, Over-current protection
	Compressor		Over-heat protection	Over-heat protection	Over-heat protection
Refrigerant	Type x original charge		R410A x 5.0kg (12lbs)	R410A x 5.0kg (12lbs)	R410A x 5.0kg (12lbs)
	Control		LEV and HIC circuit		
Net weight	kg (lbs)	195(430)	195(430)	195(430)	
Heat exchanger			plate type	plate type	plate type
	Water volume in plate	l	5.0	5.0	5.0
	Water pressure Max.	MPa	2.0	2.0	2.0
HIC circuit (HIC: Heat Inter-Changer)			Copper pipe,tube-in-tube structure	Copper pipe,tube-in-tube structure	Copper pipe,tube-in-tube structure
Pipe between unit and distributor	Liquid pipe	mm (in.)	12.7(1/2) Brazed	12.7(1/2) Brazed	12.7(1/2) Brazed
	Gas pipe	mm (in.)	22.2(7/8) Brazed	22.2(7/8) Brazed	22.2(7/8) Brazed
Drawing	External		KB94T659		
	Wiring		KE94C317	KE94C317	KE94C317
Standard attachment	Document		Installation Manual		
	Accessory		Refrigerant conn. pipe		
Optional parts			Heat Source Twinning kit: CMY-Y300VBK2 Joint: CMY-Y102S-G2,CMY-Y102L-G2,CMY-Y202-G2,CMY-Y302-G2 Header: CMY-Y104/108/1010-G		
Remarks			<ul style="list-style-type: none"> * Details on foundation work, duct work, insulation work, electrical wiring, power source switch, and other items shall be referred to the Installation Manual. * Due to continuing improvement, above specifications may be subject to change without notice. * The ambient temperature of the heat source unit needs to be kept below 40°C D.B. * The ambient relative humidity of the heat source unit needs to be kept below 80%. * The heat source unit should not be installed at outdoor. * Be sure to mount a strainer (more than 50 meshes) at the water inlet piping of the unit. * Be sure to provide interlocking for the unit operation and water circuit. 		

Notes :	Unit converter
1.Nominal cooling conditions(subject to JIS B8615-1) Indoor:27°CDB/19°CWB(81°FDB/66°FWB), Water temperature:30°C(86°F) Pipe length:7.5m(24-9/16ft.), Level difference:0m(0ft.)	kcal =kW x 860 BTU/h =kW x 3,412
2.Nominal heating conditions(subject to JIS B8615-1) Indoor:20°CDB(68°FDB), Water temperature:20°C(68°F) Pipe length:7.5m(24-9/16ft.), Level difference:0m(0ft.)	cfm =m ³ /min x 35.31 lb =kg / 0.4536
	*Above specification data is subject to rounding variation.

1. SPECIFICATIONS

DATA G8

Model			PQHY-P900YSHM-A			
Power source			3-phase 4-wire 380-400-415V 50/60Hz			
Cooling capacity (Nominal)	*1	kW	101.0			
	*1	kcal / h	86,900			
	*1	BTU / h	344,600			
		Power input	kW	23.22		
		Current input	A	39.1-37.2-35.8		
	COP	kW / kW	4.34			
Temp. range of cooling	Indoor	W.B.	15.0 ~ 24.0°C(59 ~ 75°F)			
	Circulating water	°C	10.0 ~ 45.0°C(50 ~ 113°F)			
Heating capacity (Nominal)	*2	kW	113.0			
	*2	kcal / h	97,200			
	*2	BTU / h	385,600			
		Power input	kW	25.67		
		Current input	A	43.3-41.1-39.6		
	COP	kW / kW	4.40			
Temp. range of heating	Indoor	D.B.	15.0 ~ 27.0°C(59 ~ 81°F)			
	Circulating water	°C	10.0 ~ 45.0°C(50 ~ 113°F)			
Indoor unit connectable	Total capacity		50 ~ 130 % of heat source unit capacity			
	Model / Quantity		P15 ~ P250 / 2 ~ 50			
Sound pressure level (measured in anechoic room)			dB <A>			
			55			
Refrigerant piping diameter	Liquid pipe	mm (in.)	19.05(3/4) Brazed			
	Gas pipe	mm (in.)	41.28(1-5/8) Brazed			

Set Model								
Model			PQHY-P300YHM-A		PQHY-P300YHM-A		PQHY-P300YHM-A	
Circulating water	Water flow rate	m ³ / h	5.76 + 5.76 + 5.76					
		L / min	96 + 96 + 96					
		cfm	3.4 + 3.4 + 3.4					
	Pressure drop	kPa	17		17		17	
Operating volume range	m ³ / h	4.5 + 4.5 + 4.5 ~ 7.2 + 7.2 + 7.2						
Compressor	Type x Quantity		Inverter scroll hermetic compressor		Inverter scroll hermetic compressor		Inverter scroll hermetic compressor	
	Manufacture		AC&R Works, MITSUBISHI ELECTRIC CORPORATION		AC&R Works, MITSUBISHI ELECTRIC CORPORATION		AC&R Works, MITSUBISHI ELECTRIC CORPORATION	
	Starting method		Inverter		Inverter		Inverter	
	Motor output	kW	7.4		7.4		7.4	
	Case heater	kW	0.035(240 V)		0.035(240 V)		0.035(240 V)	
	Lubricant		MEL32		MEL32		MEL32	
External finish			Acrylic painted steel plate		Acrylic painted steel plate		Acrylic painted steel plate	
External dimension HxWxD	mm		1,160(1,100 without legs) x 880 x 550		1,160(1,100 without legs) x 880 x 550		1,160(1,100 without legs) x 880 x 550	
		in.	45-11/16(43-5/16 without legs) x 34-11/16 x 21-11/16		45-11/16(43-5/16 without legs) x 34-11/16 x 21-11/16		45-11/16(43-5/16 without legs) x 34-11/16 x 21-11/16	
Protection devices	High pressure protection		High pressure sensor, High pressure switch at 4.15MPa (601 psi)		High pressure sensor, High pressure switch at 4.15MPa (601 psi)		High pressure sensor, High pressure switch at 4.15MPa (601 psi)	
	Inverter circuit (COMP.)		Over-heat protection, Over-current protection		Over-heat protection, Over-current protection		Over-heat protection, Over-current protection	
	Compressor		Over-heat protection		Over-heat protection		Over-heat protection	
Refrigerant	Type x original charge		R410A x 5.0kg (12lbs)		R410A x 5.0kg (12lbs)		R410A x 5.0kg (12lbs)	
	Control		LEV and HIC circuit					
Net weight			kg (lbs)		195(430)		195(430)	
Heat exchanger			plate type		plate type		plate type	
	Water volume in plate	l	5.0		5.0		5.0	
	Water pressure Max.	MPa	2.0		2.0		2.0	
HIC circuit (HIC: Heat Inter-Changer)			Copper pipe,tube-in-tube structure		Copper pipe,tube-in-tube structure		Copper pipe,tube-in-tube structure	
Pipe between unit and distributor	Liquid pipe	mm (in.)	12.7(1/2) Brazed		12.7(1/2) Brazed		12.7(1/2) Brazed	
	Gas pipe	mm (in.)	22.2(7/8) Brazed		22.2(7/8) Brazed		22.2(7/8) Brazed	
Drawing	External		KB94T659		KB94T659		KB94T659	
	Wiring		KE94C317		KE94C317		KE94C317	
Standard attachment	Document		Installation Manual					
	Accessory		Refrigerant conn. pipe					
Optional parts			Heat Source Twinning kit: CMY-Y300VBK2 Joint: CMY-Y102S-G2,CMY-Y102L-G2,CMY-Y202-G2,CMY-Y302-G2 Header: CMY-Y104/108/1010-G					
Remarks			<p>* Details on foundation work, duct work, insulation work, electrical wiring, power source switch, and other items shall be referred to the Installation Manual.</p> <p>* Due to continuing improvement, above specifications may be subject to change without notice.</p> <p>* The ambient temperature of the heat source unit needs to be kept below 40°C D.B.</p> <p>* The ambient relative humidity of the heat source unit needs to be kept below 80%.</p> <p>* The heat source unit should not be installed at outdoor.</p> <p>* Be sure to mount a strainer (more than 50 meshes) at the water inlet piping of the unit.</p> <p>* Be sure to provide interlocking for the unit operation and water circuit.</p>					

Notes :		Unit converter
1.Nominal cooling conditions(subject to JIS B8615-1) Indoor:27°CDB/19°CWB(81°FDB/66°FWB), Water temperature:30°C(86°F) Pipe length:7.5m(24-9/16ft.), Level difference:0m(0ft.)		kcal =kW x 860
2.Nominal heating conditions(subject to JIS B8615-1) Indoor:20°CDB(68°FDB), Water temperature:20°C(68°F) Pipe length:7.5m(24-9/16ft.), Level difference:0m(0ft.)		BTU/h =kW x 3,412
		cfm =m ³ /min x 35.31
		lb =kg / 0.4536
		*Above specification data is subject to rounding variation.

PQHY-P200, 250, 300YHM-A

Unit : mm

- Note 1. Close a hole of the water piping, the refrigerant piping, the power supply, and the control wiring and unused knockout holes with the putty etc. so as not to infiltrate rain water etc. (field erection work)
- Note 2. At the time of product shipment, the front side piping specification serves as the local drainage connection. When connecting on the rear side, please remove the rear side plug sealing corks, and attach a front side. Ensure there is no leak after the attachment has been fitted.
- Note 3. Take notice of service space as Fig. A. (In case of single installation, 600mm or more of back space as front space makes easier access when servicing the unit from rear side)
- Note 4. If water pipes or refrigerant pipes stretch upward, required space for service and maintenance due to replacement of control box is shown in Fig. B.
- Note 5. Environmental condition for installation; -20~40°C (DB) as indoor installation.
- Note 6. In case the temperature around the heat source unit has possibility to drop under 0°C, be careful for the following point to prevent the pipe burst by the water pipe freeze-up.
 - Circulate the water all the time even if the heat source unit is not in operation.
 - Drain the water from inside of the heat source unit when the heat source unit will not operate for a long term.
- Note 7. Ensure that the drain piping is downward with a pitch of more than 1/100.
- Note 8. The detachable leg can be removed at site.
- Note 9. At brazing of pipes, wrap the refrigerant service valve with wet cloth and keep the temperature of refrigerant service valve under 120°C.

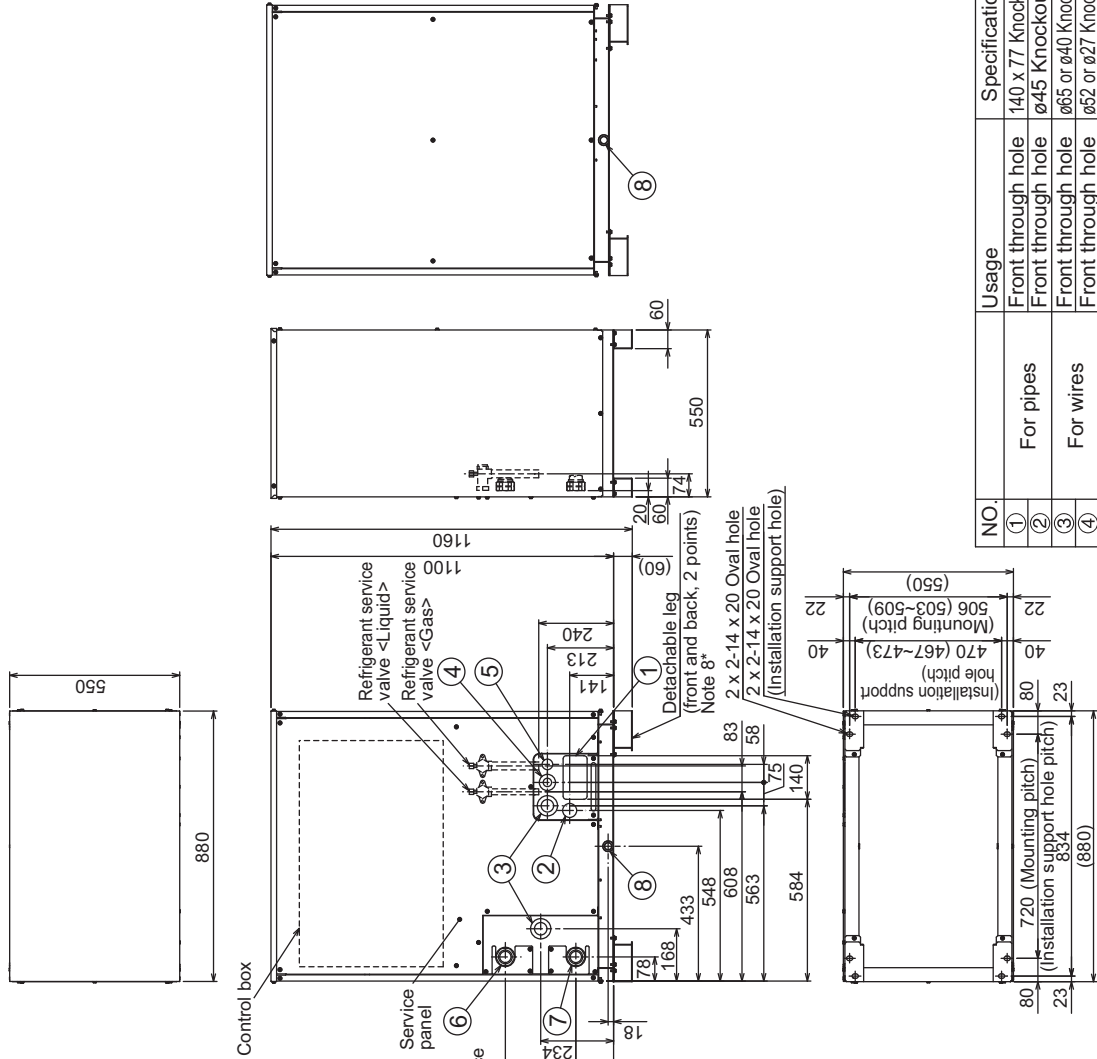

Fig. B

Fig. A

<Accessories>

- Refrigerant (Liquid) conn. pipe1 pc. (P200/P250/P300 ; Packaged in the accessory kit)
- Refrigerant (Gas) conn. pipe1 pc. (P200/P250/P300 ; Packaged in the accessory kit)

Connecting pipe specifications

Model	Connection specifications for the refrigerant service valve	
	Liquid	Gas
PQHY-P200YHM-A	ø19.05 Brazed *1	Gas
PQHY-P250YHM-A	ø9.52 Brazed *1	ø19.05 Brazed *1
PQHY-P300YHM-A	ø22.2 Brazed *1	ø22.2 Brazed *1

*1. Connect by using the connecting pipes that are supplied.

NO.	Usage	Specifications
①	Front through hole	140 x 77 Knockout hole
②	For pipes	ø45 Knockout hole
③	For wires	ø65 or ø40 Knockout hole
④	For transmission cables	ø52 or ø27 Knockout hole
⑤	Water pipe inlet	ø34 Knockout hole
⑥	Drain pipe outlet	Rc1-1/2 Screw
⑧		Rc3/4 Screw

PQHY-P400, 450, 500, 550, 600YSHM-A

Unit : mm

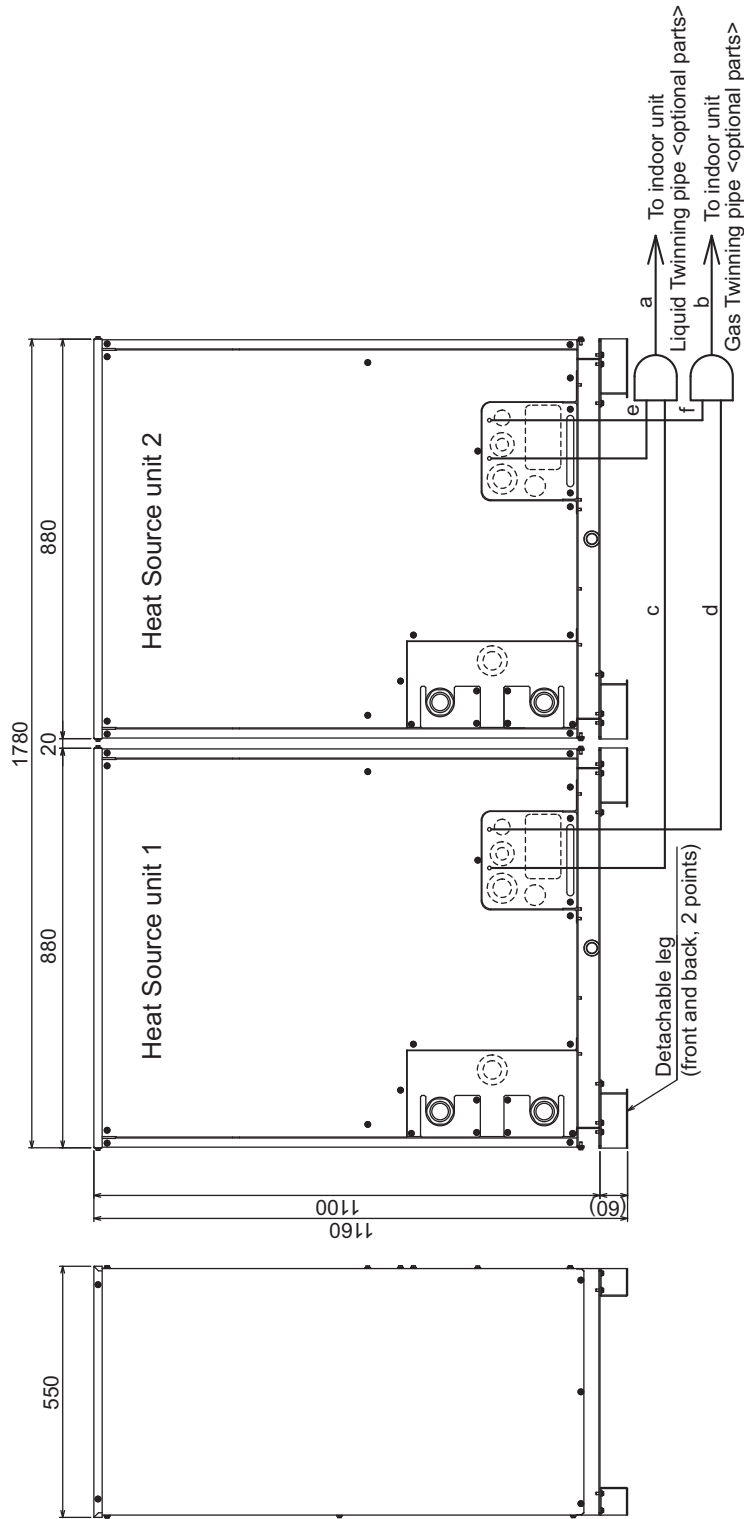

- Note 1. Connect the pipes as shown in the figure above. Refer to the table below for the pipe size.
 2. The detachable leg can be removed at site.
 3. Twinning pipe should not be tilted more than 15 degrees from the ground.
 4. See the Installation Manual for the details of Twinning pipe installation.
 5. The length of the straight part of pipe connected in front of the twinning pipe must be 500mm (19inch) or longer.

Twinning pipe connection size

Package unit name	PQHY-P400YSHM-A	PQHY-P450YSHM-A	PQHY-P500YSHM-A	PQHY-P550YSHM-A	PQHY-P600YSHM-A
Heat Source unit 1	PQHY-P200YHM-A	PQHY-P250YHM-A	PQHY-P300YHM-A	PQHY-P300YHM-A	PQHY-P300YHM-A
Heat Source unit 2	PQHY-P200YHM-A	PQHY-P200YHM-A	PQHY-P250YHM-A	PQHY-P250YHM-A	PQHY-P300YHM-A
Twinning pipe Kit (optional parts)	CMY-Y100VBK2				
Indoor unit ~ Liquid	a	ø12.7	ø15.88		
Indoor unit ~ Gas	b	ø28.58			
Twinning pipe ~ Liquid	c	ø9.52	ø12.7		
Heat Source unit 1 Gas	d	ø22.2			
Twinning pipe ~ Liquid	e	ø9.52	ø12.7		
Heat Source unit 2 Gas	f	ø22.2			

WY

PQHY-P650, 700, 750, 800, 850, 900YSHM-A

Unit : mm

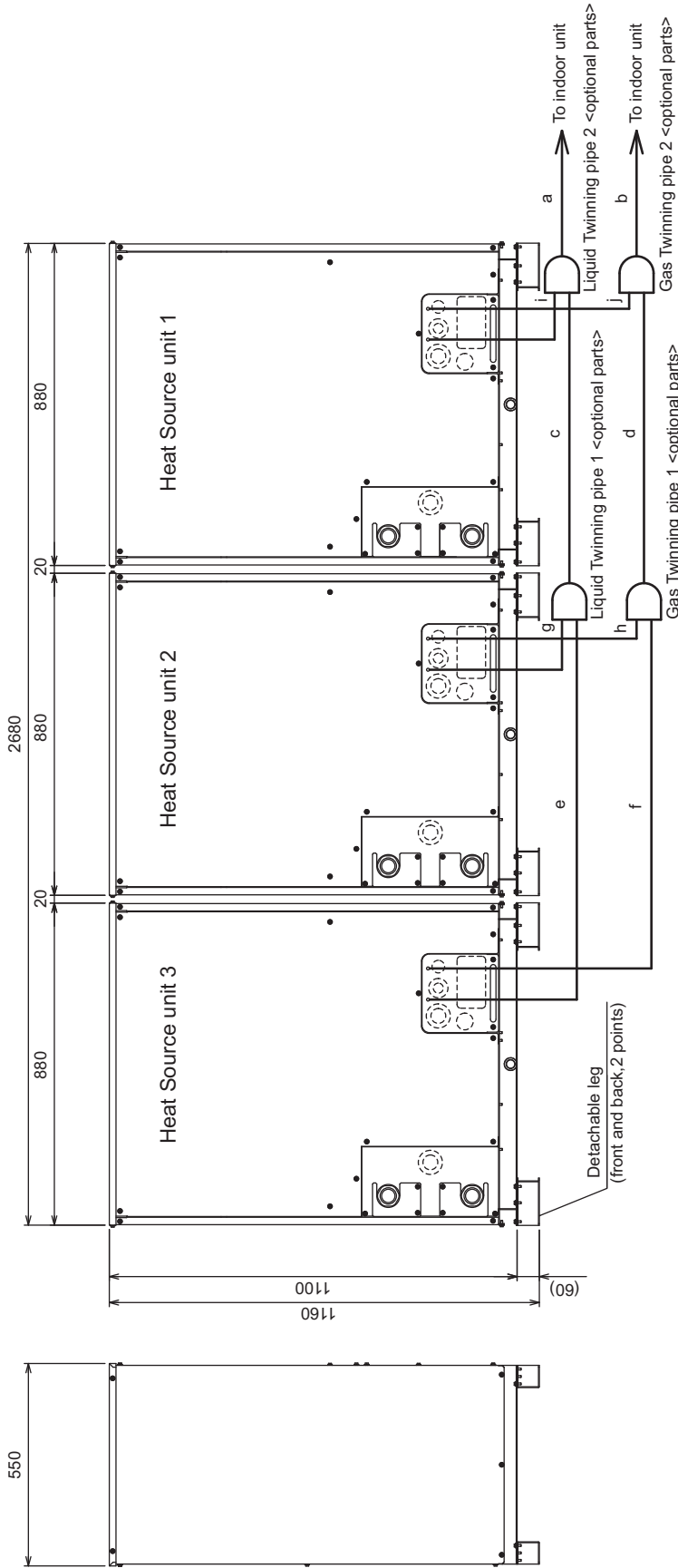

Twinning pipe connection size											
Package unit name	PQHY-P650YSHM-A	PQHY-P700YSHM-A	PQHY-P750YSHM-A	PQHY-P800YSHM-A	PQHY-P850YSHM-A	PQHY-P900YSHM-A					
Heat Source unit 1	PQHY-P250YHM-A	PQHY-P250YHM-A	PQHY-P250YHM-A	PQHY-P300YHM-A	PQHY-P300YHM-A	PQHY-P300YHM-A					
Heat Source unit 2	PQHY-P200YHM-A	PQHY-P250YHM-A	PQHY-P250YHM-A	PQHY-P250YHM-A	PQHY-P300YHM-A	PQHY-P300YHM-A					
Heat Source unit 3	PQHY-P200YHM-A	PQHY-P200YHM-A	PQHY-P250YHM-A	PQHY-P250YHM-A	PQHY-P250YHM-A	PQHY-P300YHM-A					
Twinning pipe Kit (optional parts)	GMV-Y300VBK2										
Indoor unit- Twinning pipe 2	a	ø34.93		ø19.05		ø41.28					
Twinning pipe 1- Twinning pipe 2	Liquid	ø34.93		ø19.05		ø41.28					
	Gas	ø34.93		ø19.05		ø41.28					

Unit model	Liquid e or g or i	Gas for or j
P200	ø12.7	ø19.05
P250	ø12.7	ø19.05
P300	ø12.7	ø22.2

- Note 1. Connect the pipes as shown in the figure above. Refer to the table below for the pipe size.
 2. The detachable leg can be removed at site.
 3. Twinning pipe should not be tilted more than 15 degrees from the ground.
 4. See the Installation Manual for the details of Twinning pipe installation.
 5. The pipe section before the Twinning pipe (sections "g", "b", "c" and "d" in the figure) must have at least 500mm(19inch) of straight section (*including the straight pipe that is supplied with the Twinning pipe).
 6. Only use the Twinning pipe by Mitsubishi (optional parts).

WM

PQHY-P200,250,300YHM-A

Unit : mm[in.]

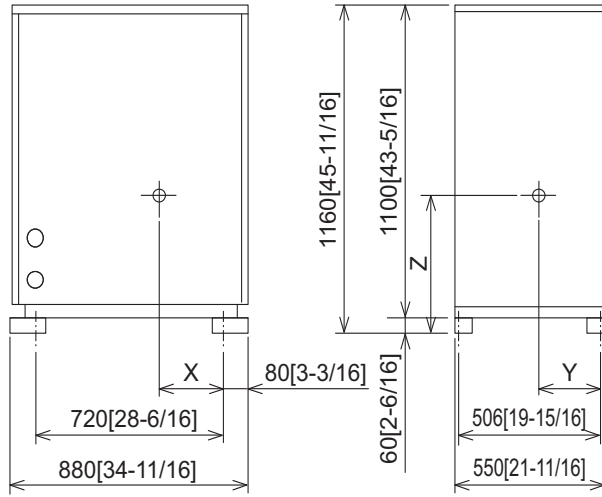

Model	X	Y	Z
PQHY-P200YHM-A	418[16-8/16]	250[9-14/16]	532[21]
PQHY-P250YHM-A	418[16-8/16]	250[9-14/16]	532[21]
PQHY-P300YHM-A	418[16-8/16]	250[9-14/16]	532[21]

WY

PQHY-P200,250,300YHM-A

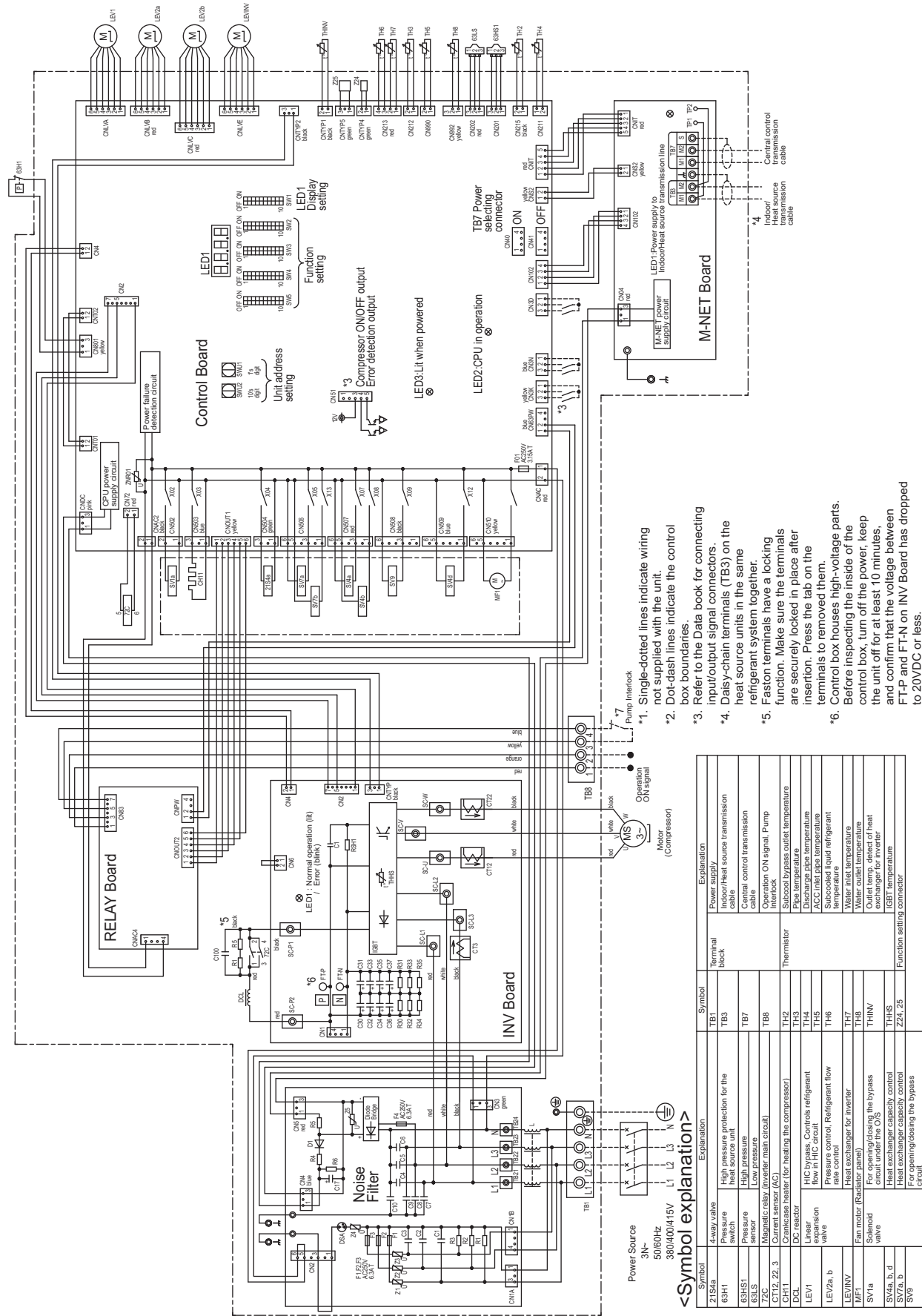

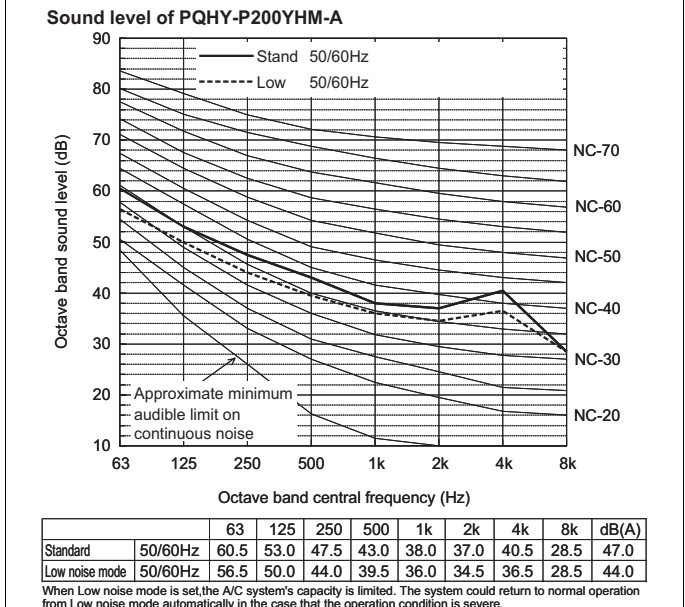
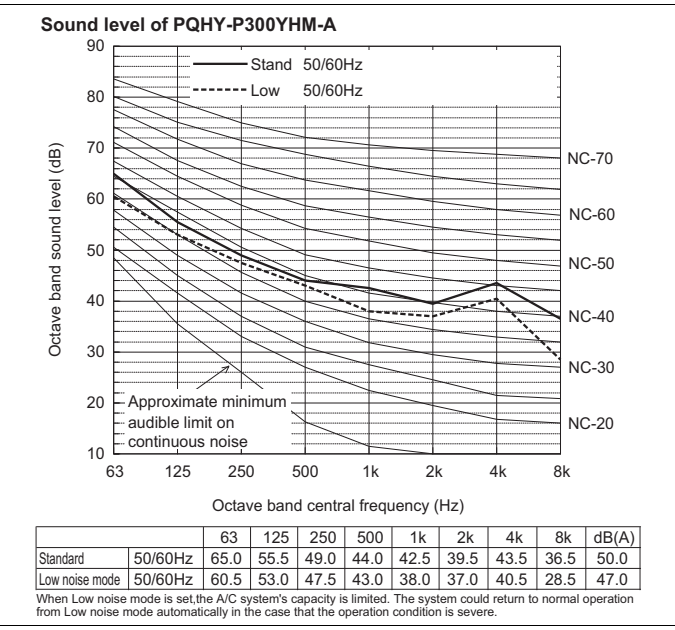
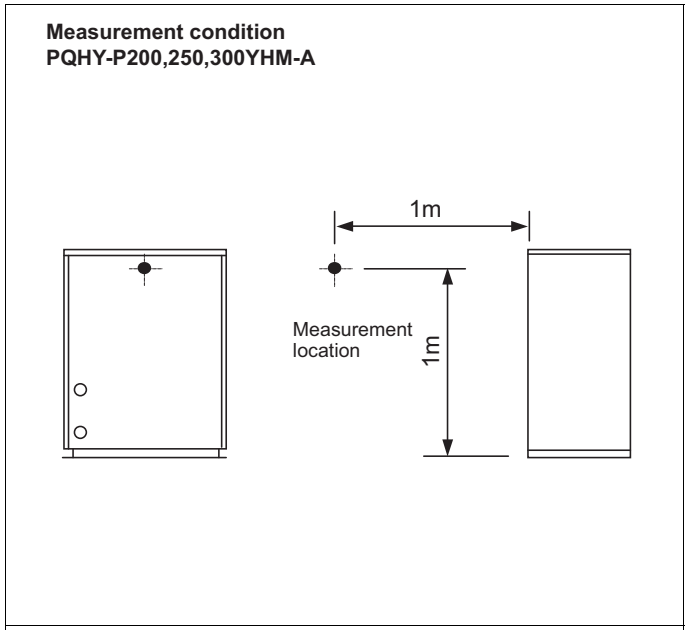

WY

Measurement condition
PQHY-P400,450,500,550,600YSHM-A

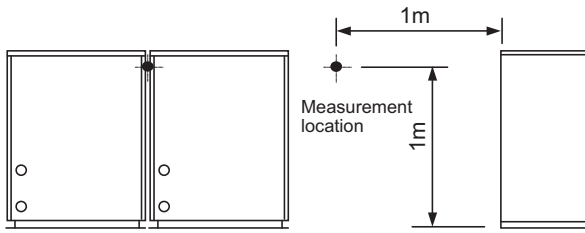

Sound level of PQHY-P500YSHM-A

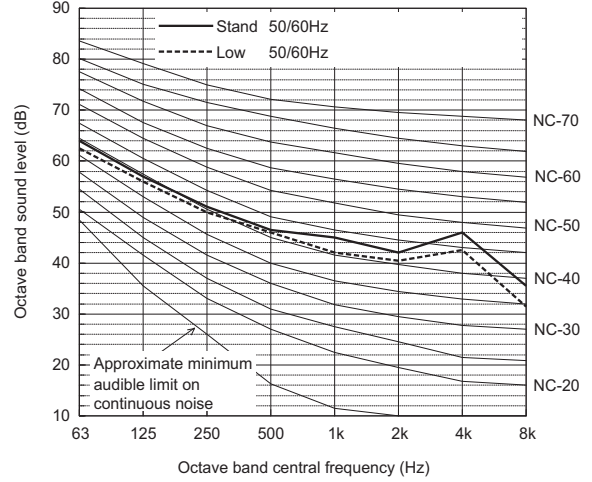

		63	125	250	500	1k	2k	4k	8k	dB(A)
Standard	50/60Hz	64.0	57.0	51.0	46.5	45.0	42.0	46.0	35.5	52.0
Low noise mode	50/60Hz	62.5	56.0	50.0	46.0	42.0	40.5	42.5	31.5	50.0

When Low noise mode is set, the A/C system's capacity is limited. The system could return to normal operation from Low noise mode automatically in the case that the operation condition is severe.

Sound level of PQHY-P400YSHM-A

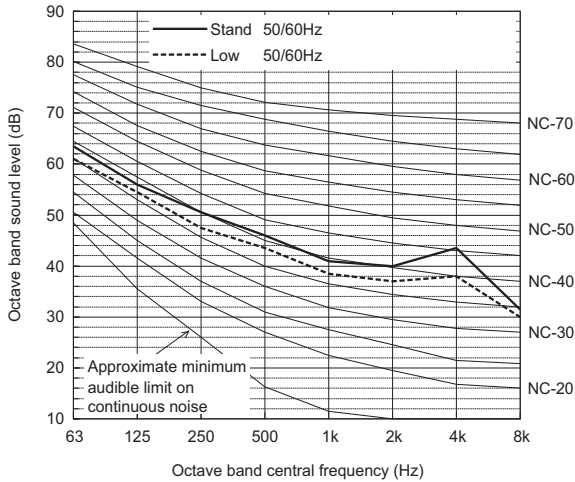

		63	125	250	500	1k	2k	4k	8k	dB(A)
Standard	50/60Hz	63.5	56.0	50.5	46.0	41.0	40.0	43.5	31.5	50.0
Low noise mode	50/60Hz	61.0	54.5	47.5	43.5	38.5	37.0	38.0	30.0	47.0

When Low noise mode is set, the A/C system's capacity is limited. The system could return to normal operation from Low noise mode automatically in the case that the operation condition is severe.

Sound level of PQHY-P550YSHM-A

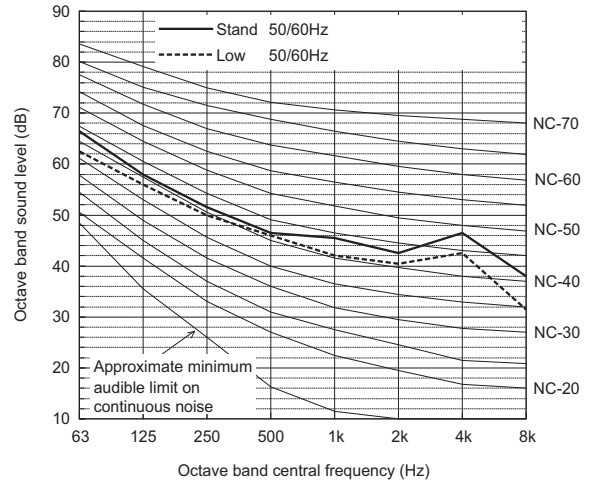

		63	125	250	500	1k	2k	4k	8k	dB(A)
Standard	50/60Hz	66.5	58.0	51.5	46.5	45.5	42.5	46.5	38.0	52.5
Low noise mode	50/60Hz	62.5	56.0	50.0	46.0	42.0	40.5	42.5	31.5	50.0

When Low noise mode is set, the A/C system's capacity is limited. The system could return to normal operation from Low noise mode automatically in the case that the operation condition is severe.

Sound level of PQHY-P450YSHM-A

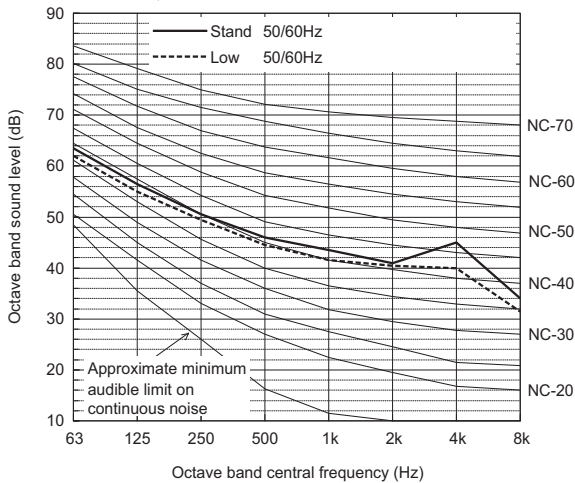

		63	125	250	500	1k	2k	4k	8k	dB(A)
Standard	50/60Hz	63.5	56.5	50.5	46.0	43.5	41.0	45.0	34.0	51.0
Low noise mode	50/60Hz	62.0	55.0	49.5	44.5	41.5	40.5	40.0	31.5	49.0

When Low noise mode is set, the A/C system's capacity is limited. The system could return to normal operation from Low noise mode automatically in the case that the operation condition is severe.

Sound level of PQHY-P600YSHM-A

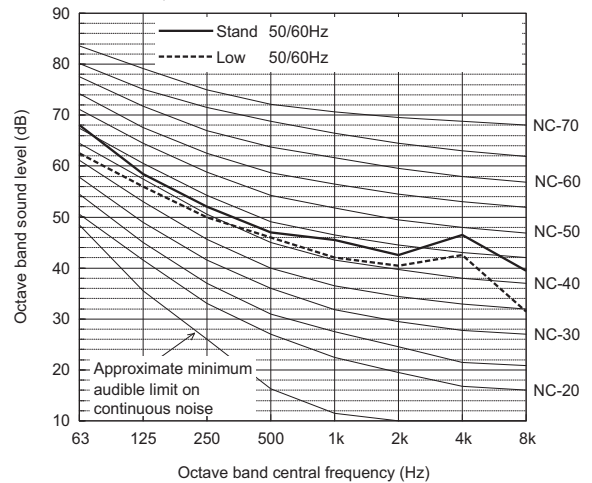

		63	125	250	500	1k	2k	4k	8k	dB(A)
Standard	50/60Hz	68.0	58.5	52.0	47.0	45.5	42.5	46.5	39.5	53.0
Low noise mode	50/60Hz	62.5	56.0	50.0	46.0	42.0	40.5	42.5	31.5	50.0

When Low noise mode is set, the A/C system's capacity is limited. The system could return to normal operation from Low noise mode automatically in the case that the operation condition is severe.

Measurement condition
PQHY-P650, 700, 750, 800, 850YSHM-A

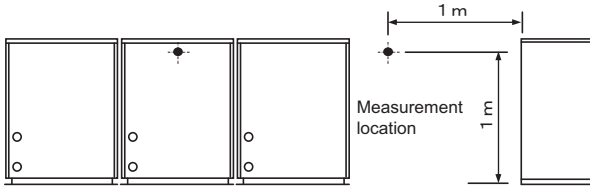

Sound level of PQHY-P750YSHM-A

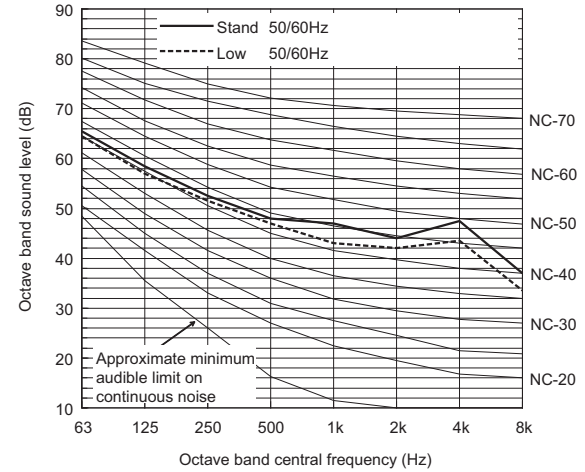

		63	125	250	500	1k	2k	4k	8k	dB(A)
Standard	50/60Hz	65.5	58.5	52.5	48.0	47.0	44.0	47.5	37.0	54.0
Low noise mode	50/60Hz	64.5	57.0	51.5	47.0	43.0	42.0	43.5	33.5	51.5

When Low noise mode is set, the A/C system's capacity is limited. The system could return to normal operation from Low noise mode automatically in the case that the operation condition is severe.

Sound level of PQHY-P650YSHM-A

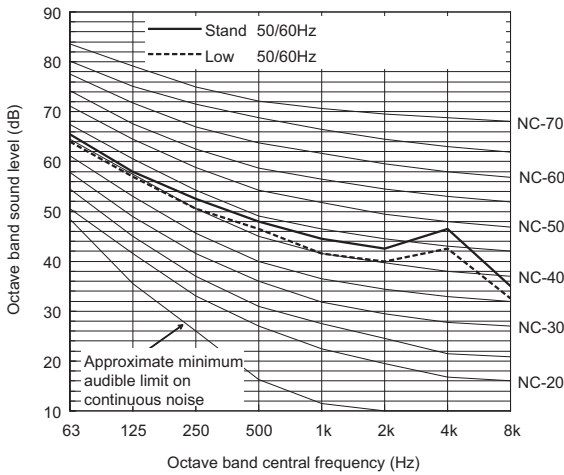

		63	125	250	500	1k	2k	4k	8k	dB(A)
Standard	50/60Hz	65.5	58.0	52.5	48.0	44.5	42.5	46.5	35.0	53.0
Low noise mode	50/60Hz	64.0	57.0	50.5	46.5	41.5	40.0	42.5	32.5	50.5

When Low noise mode is set, the A/C system's capacity is limited. The system could return to normal operation from Low noise mode automatically in the case that the operation condition is severe.

Sound level of PQHY-P800YSHM-A

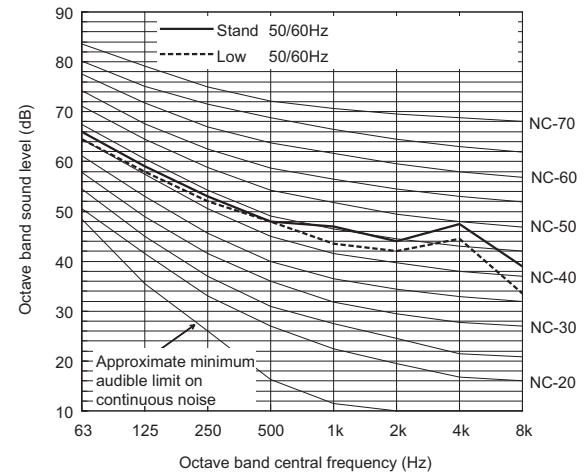

		63	125	250	500	1k	2k	4k	8k	dB(A)
Standard	50/60Hz	66.0	59.0	53.0	48.0	47.0	44.0	47.5	39.0	54.0
Low noise mode	50/60Hz	64.5	58.0	52.0	48.0	43.5	42.0	44.5	33.5	52.0

When Low noise mode is set, the A/C system's capacity is limited. The system could return to normal operation from Low noise mode automatically in the case that the operation condition is severe.

Sound level of PQHY-P700YSHM-A

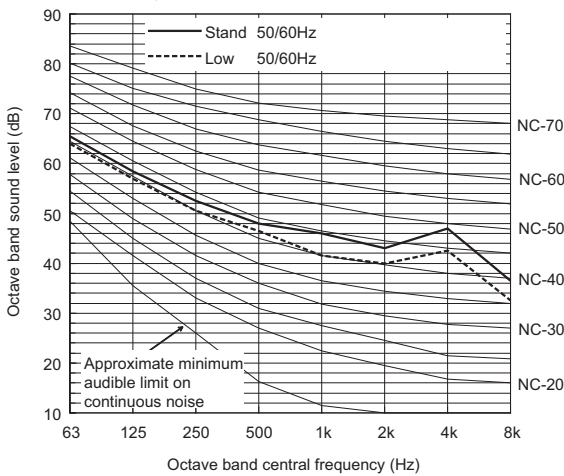

		63	125	250	500	1k	2k	4k	8k	dB(A)
Standard	50/60Hz	65.5	58.5	52.5	48.0	46.0	43.0	47.0	36.5	53.5
Low noise mode	50/60Hz	64.0	57.0	50.5	46.5	41.5	40.0	42.5	32.5	50.5

When Low noise mode is set, the A/C system's capacity is limited. The system could return to normal operation from Low noise mode automatically in the case that the operation condition is severe.

Sound level of PQHY-P850YSHM-A

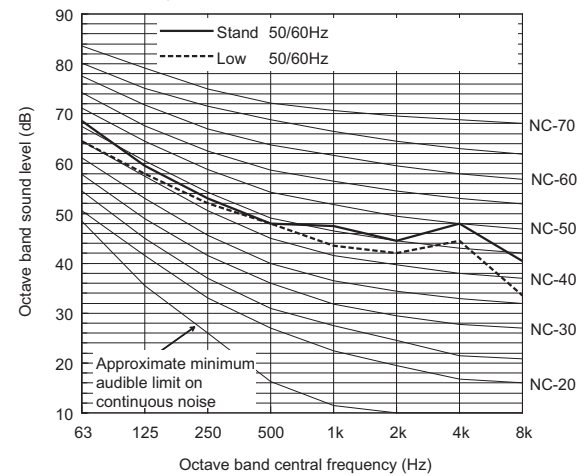

		63	125	250	500	1k	2k	4k	8k	dB(A)
Standard	50/60Hz	68.5	59.5	53.0	48.0	47.5	44.5	48.0	40.5	54.5
Low noise mode	50/60Hz	64.5	58.0	52.0	48.0	43.5	42.0	44.5	33.5	52.0

When Low noise mode is set, the A/C system's capacity is limited. The system could return to normal operation from Low noise mode automatically in the case that the operation condition is severe.

WY

Measurement condition
PQHY-P900YSHM-A

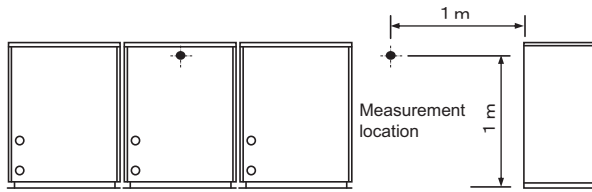

Sound level of PQHY-P900YSHM-A

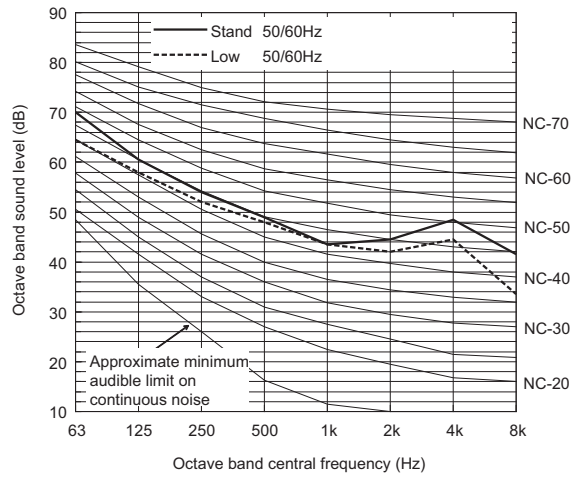

		63	125	250	500	1k	2k	4k	8k	dB(A)
Standard	50/60Hz	70.0	60.5	54.0	49.0	43.5	44.5	48.5	41.5	55.0
Low noise mode	50/60Hz	64.5	58.0	52.0	48.0	43.5	42.0	44.5	33.5	52.0

When Low noise mode is set, the A/C system's capacity is limited. The system could return to normal operation from Low noise mode automatically in the case that the operation condition is severe.

WY

6-1. Correction by temperature

CITY MULTI could have various capacities at different designing temperatures. Using the nominal cooling/heating capacity values and the ratios below, the capacity can be found for various temperatures.

		PQHY-P200YHM-A	PQRY-P200YHM-A
Nominal Cooling Capacity	kW	22.4	22.4
	BTU/h	76,400	76,400
Input	kW	3.92	3.96

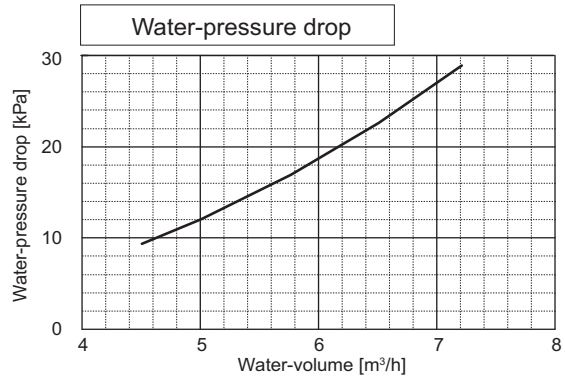
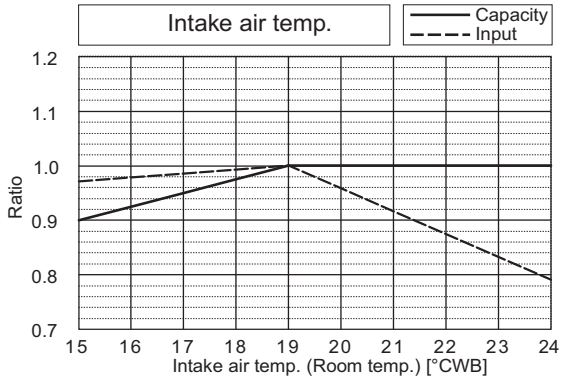
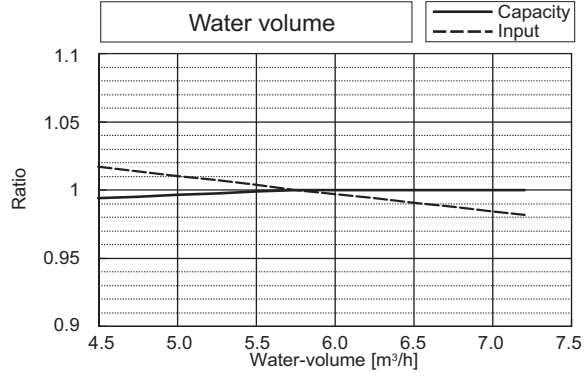
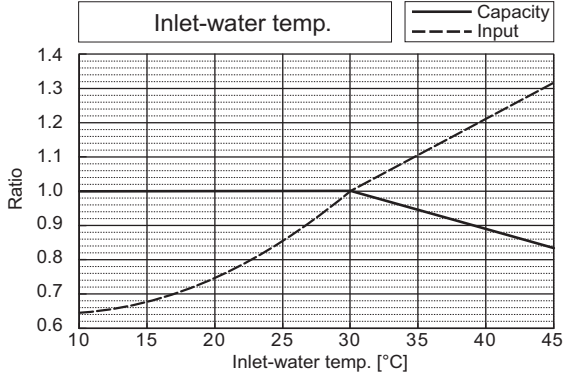

		PQHY-P200YHM-A	PQRY-P200YHM-A
Nominal Heating Capacity	kW	25.0	25.0
	BTU/h	85,300	85,300
Input	kW	4.12	4.12

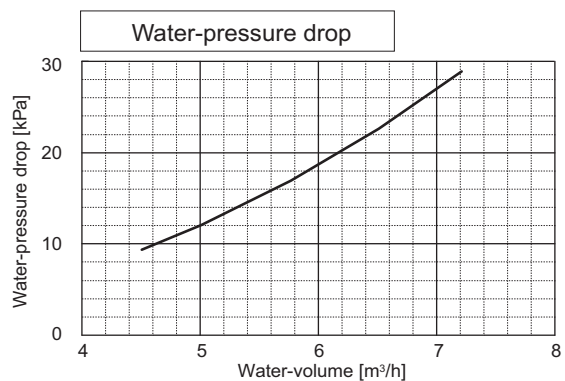
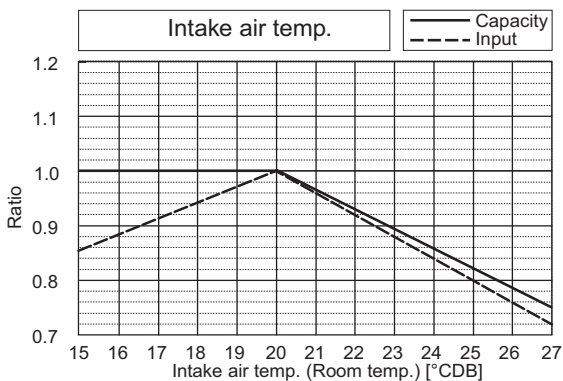
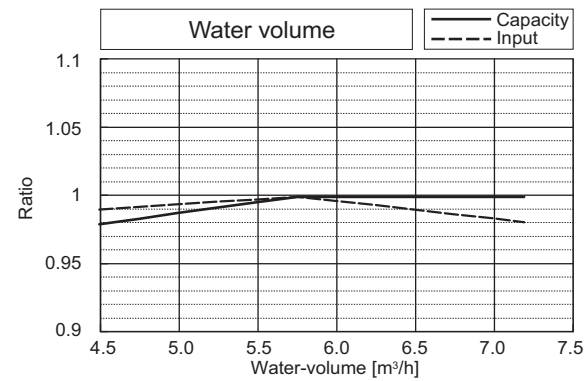
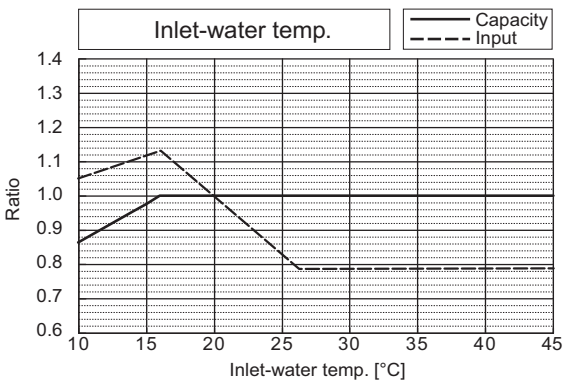

WY

6. CAPACITY TABLES

		PQHY-P250YHM-A	PQRY-P250YHM-A
Nominal Cooling Capacity	kW	28.0	28.0
	BTU/h	95,500	95,500
Input	kW	5.45	5.51

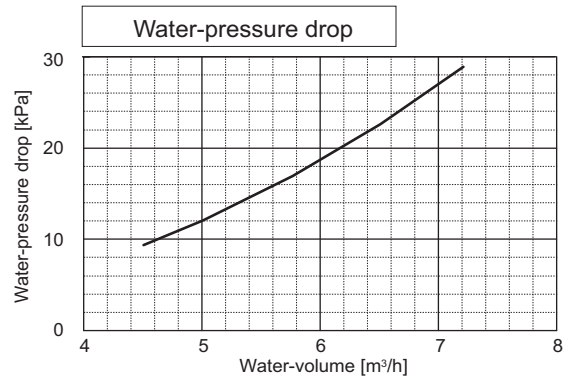
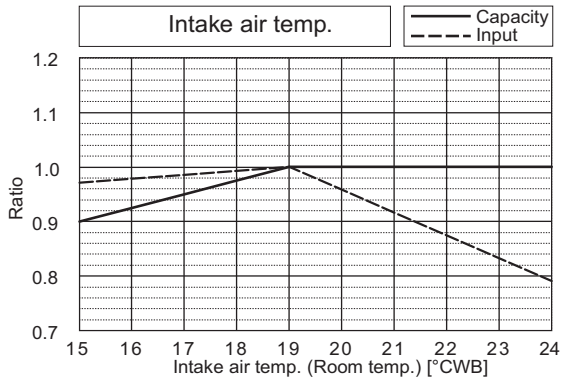
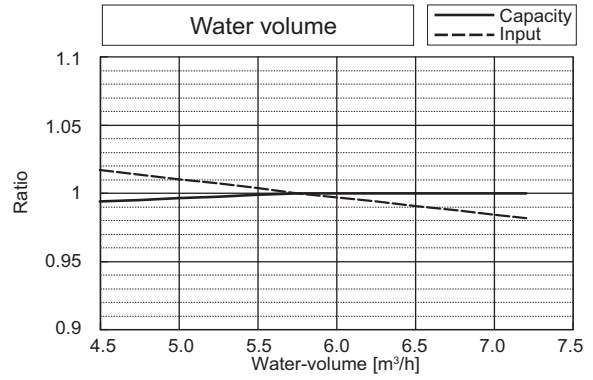
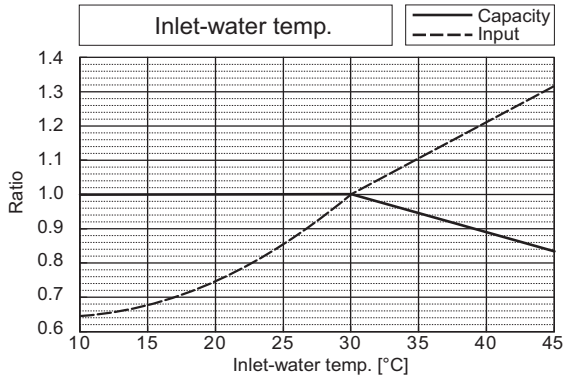

		PQHY-P250YHM-A	PQRY-P250YHM-A
Nominal Heating Capacity	kW	31.5	31.5
	BTU/h	107,500	107,500
Input	kW	5.80	5.80

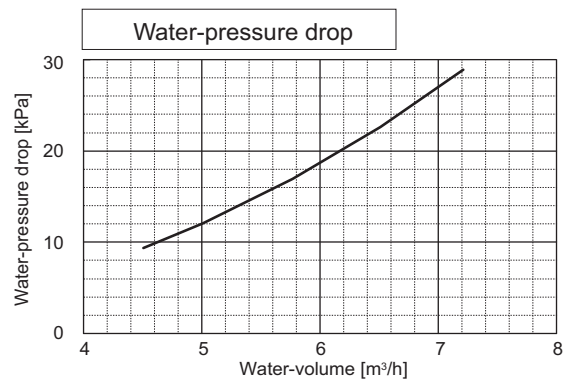
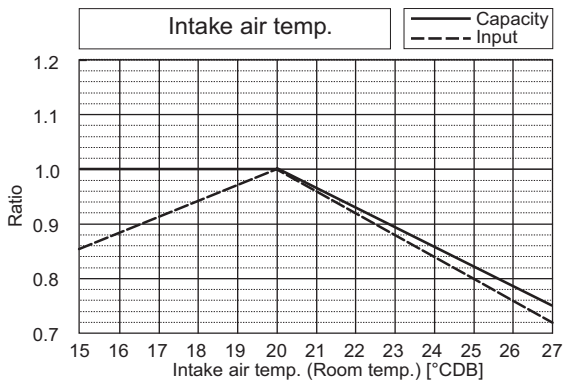
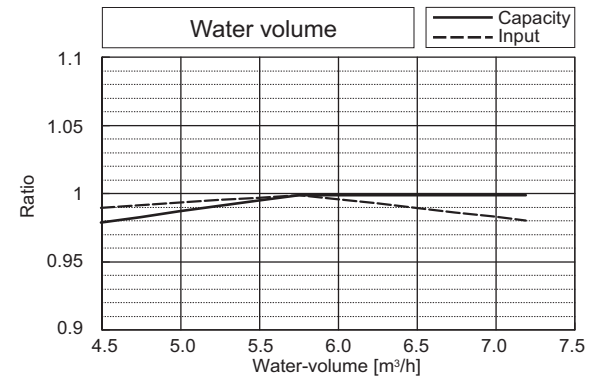
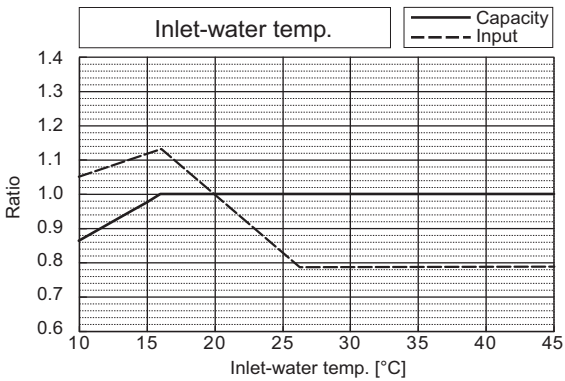

WY

6. CAPACITY TABLES

		PQHY-P300YHM-A	PQRY-P300YHM-A
Nominal Cooling Capacity	kW	33.5	33.5
	BTU/h	114,300	114,300
Input	kW	7.36	7.44

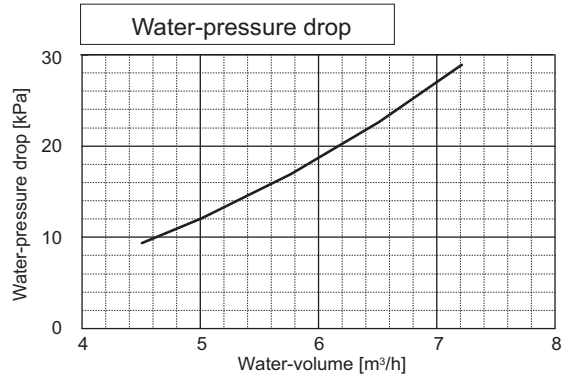
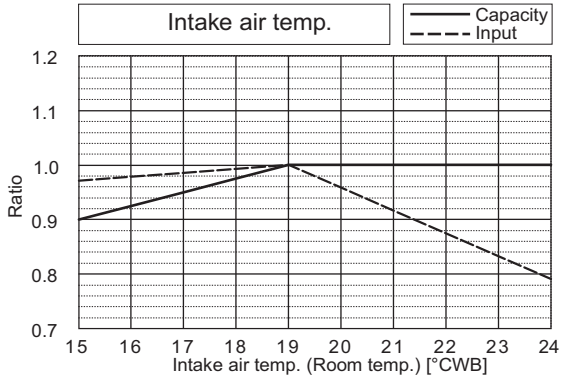
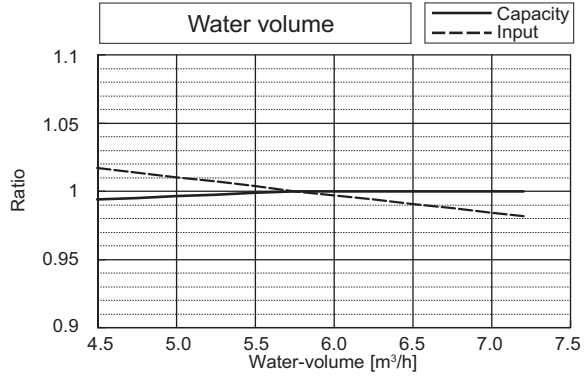
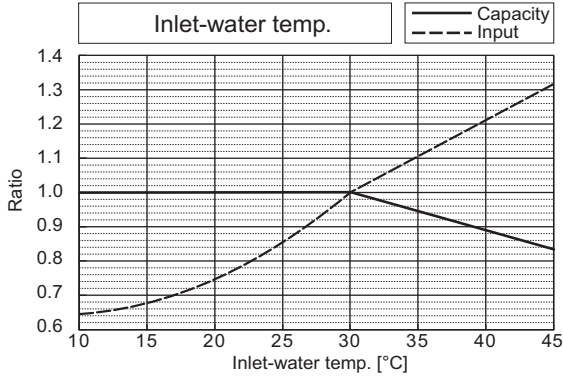

		PQHY-P300YHM-A	PQRY-P300YHM-A
Nominal Heating Capacity	kW	37.5	37.5
	BTU/h	128,000	128,000
Input	kW	8.15	8.15

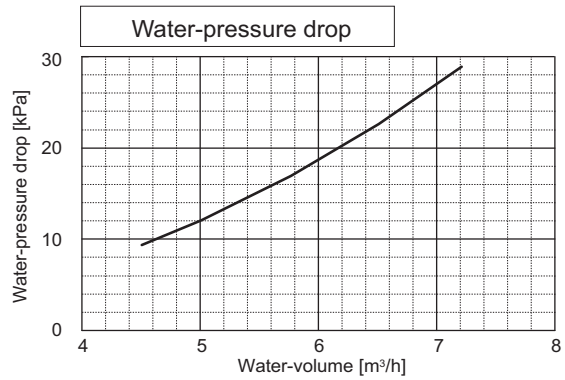
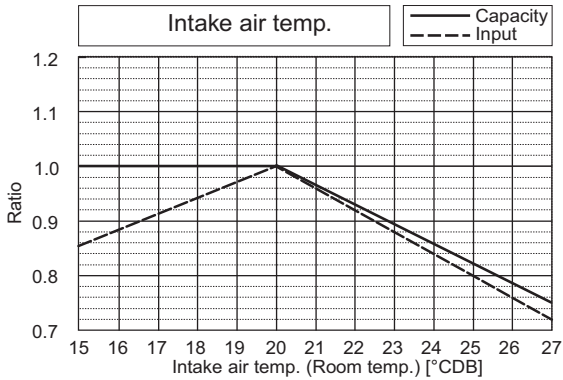
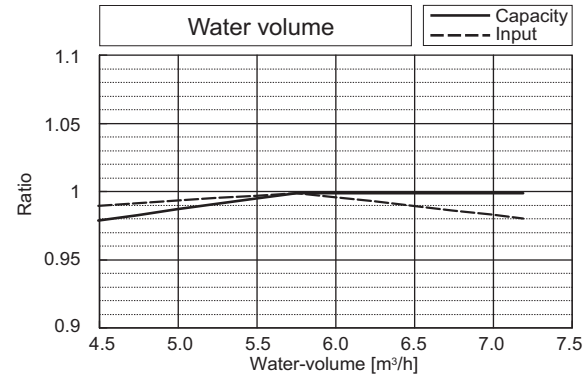
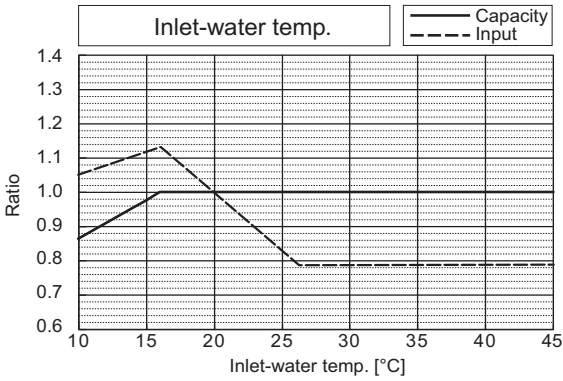

WY

6. CAPACITY TABLES

		PQHY-P400YSHM-A	PQRY-P400YSHM-A
Nominal Cooling Capacity	kW	45.0	45.0
	BTU/h	153,500	153,500
Input	kW	8.25	8.32

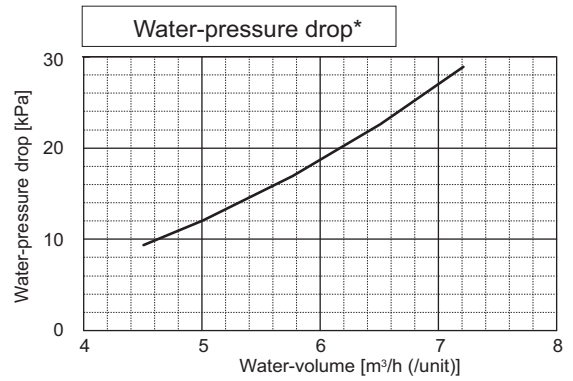
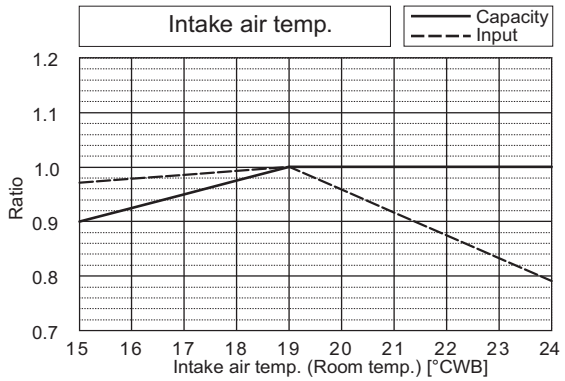
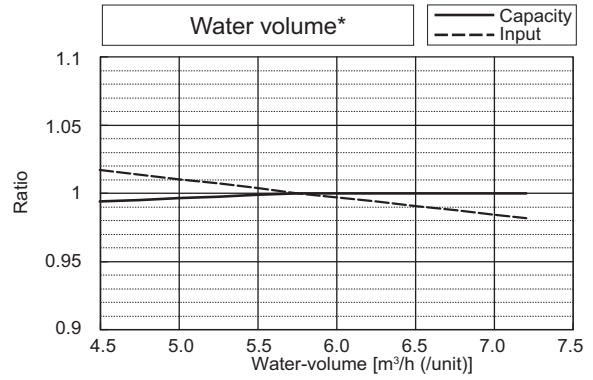
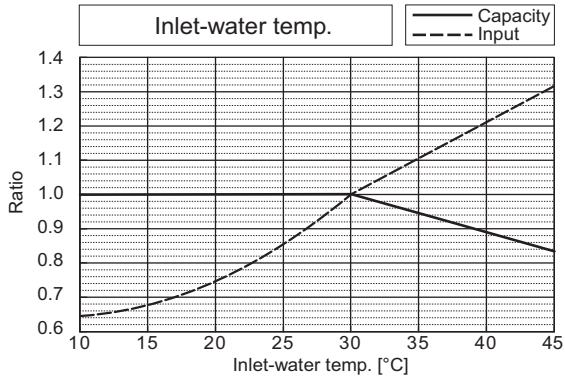

*The drawing indicates characteristic per unit.

		PQHY-P400YSHM-A	PQRY-P400YSHM-A
Nominal Heating Capacity	kW	50.0	50.0
	BTU/h	170,600	170,600
Input	kW	8.65	8.65

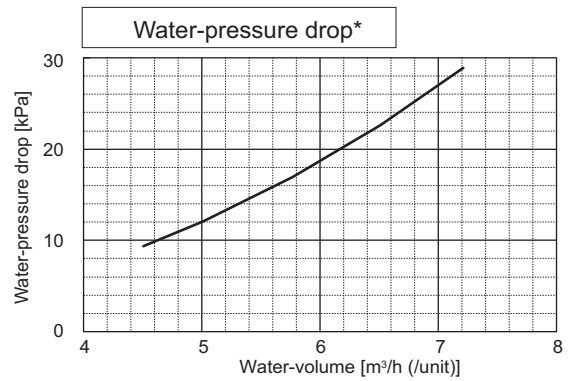
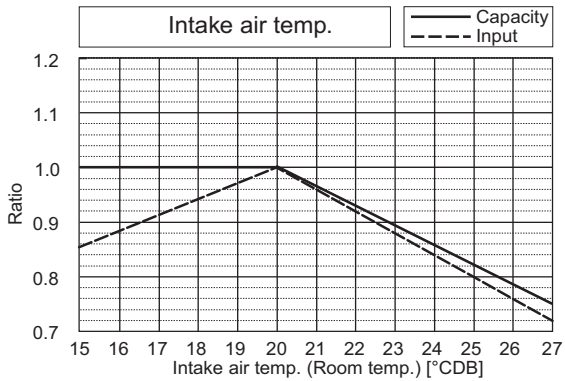
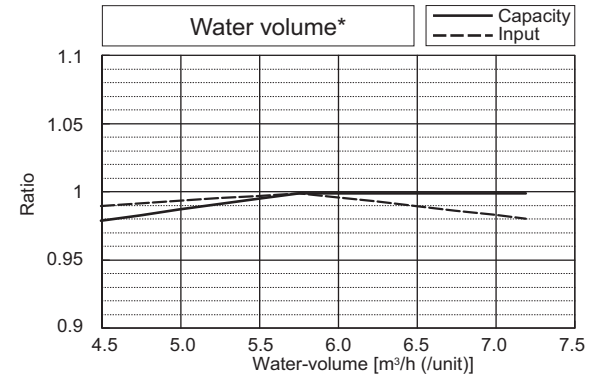
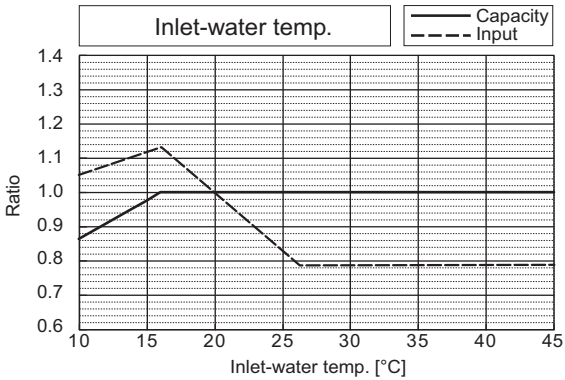

*The drawing indicates characteristic per unit.

WY

6. CAPACITY TABLES

		PQHY-P450YSHM-A	PQRY-P450YSHM-A
Nominal Cooling Capacity	kW	50.0	50.0
	BTU/h	170,600	170,600
Input	kW	9.84	9.94

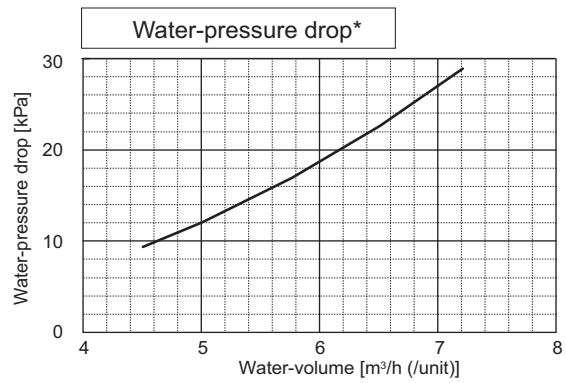
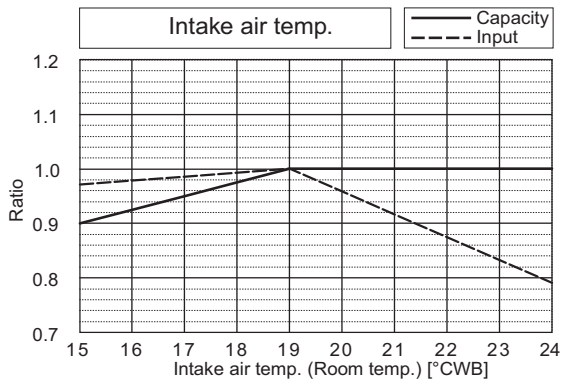
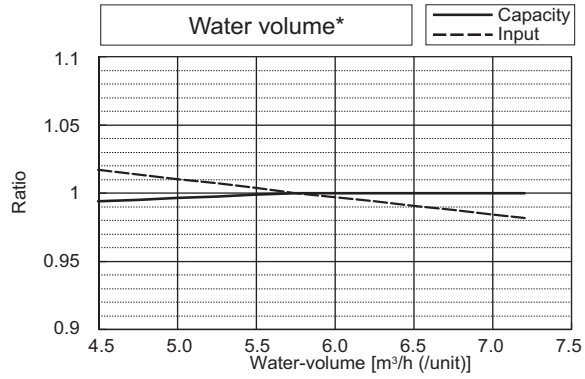
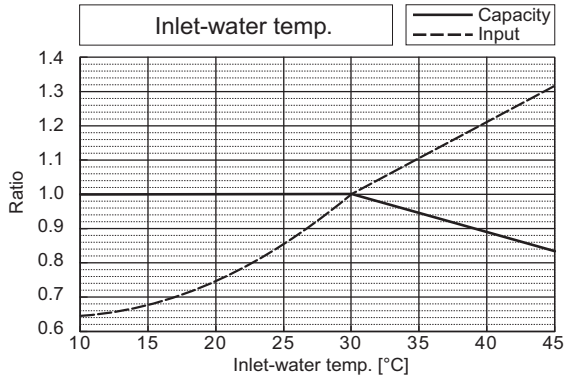

*The drawing indicates characteristic per unit.

		PQHY-P450YSHM-A	PQRY-P450YSHM-A
Nominal Heating Capacity	kW	56.0	56.0
	BTU/h	191,100	191,100
Input	kW	10.42	10.42

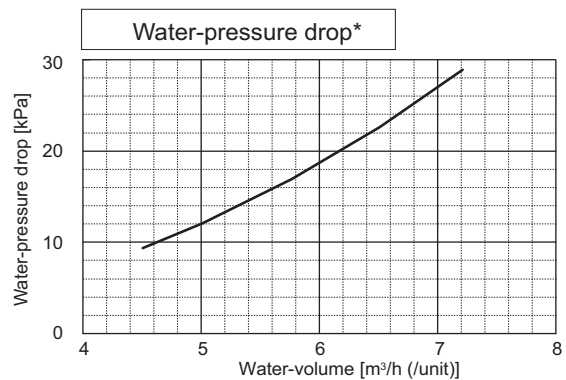
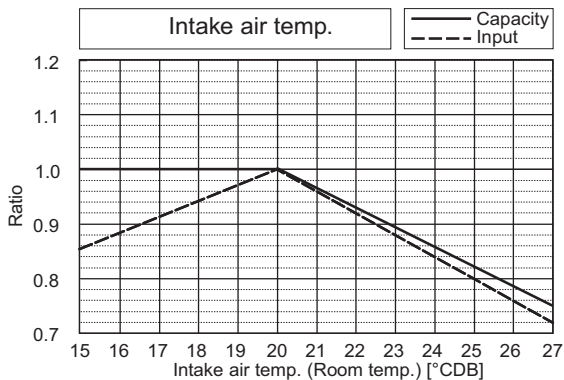
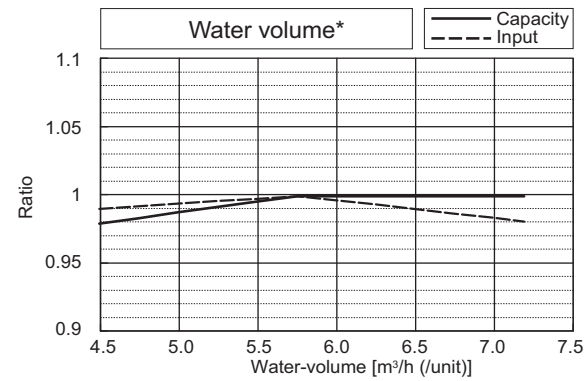
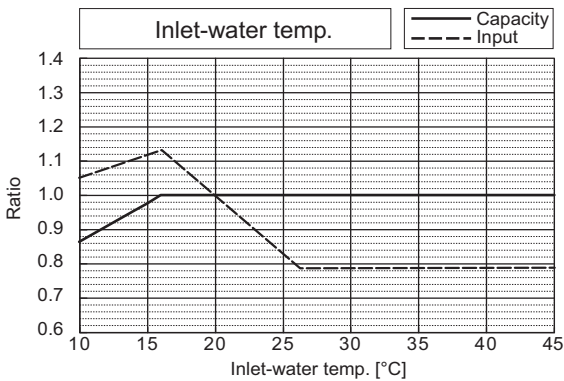

*The drawing indicates characteristic per unit.

WY

6. CAPACITY TABLES

		PQHY-P500YSHM-A	PQRY-P500YSHM-A
Nominal Cooling Capacity	kW	56.0	56.0
	BTU/h	191,100	191,100
Input	kW	11.45	11.57

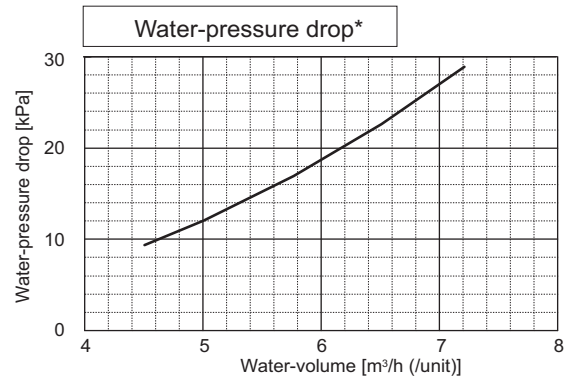
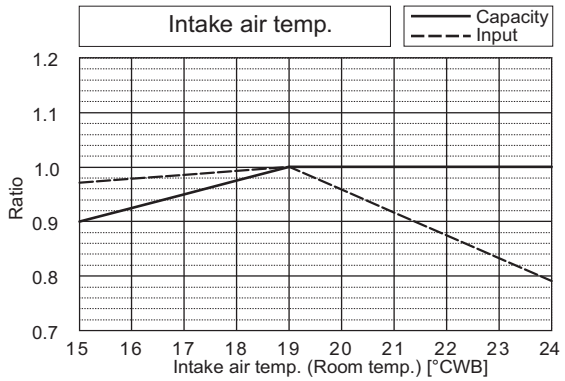
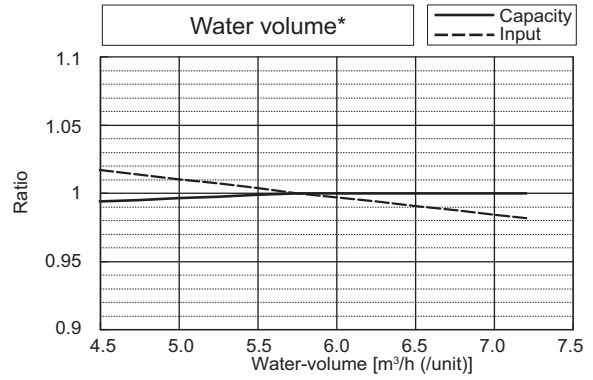
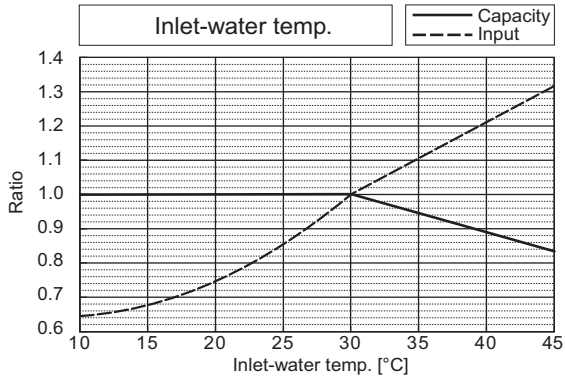

*The drawing indicates characteristic per unit.

		PQHY-P500YSHM-A	PQRY-P500YSHM-A
Nominal Heating Capacity	kW	63.0	63.0
	BTU/h	215,000	215,000
Input	kW	12.06	12.06

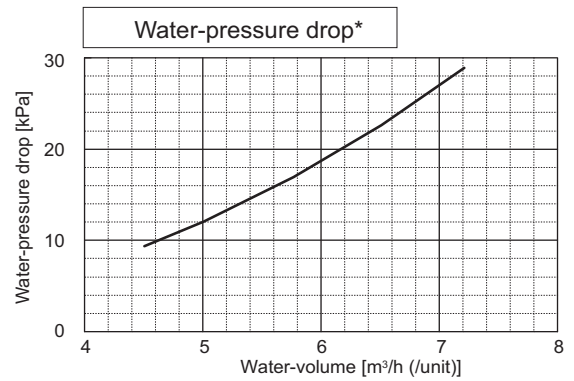
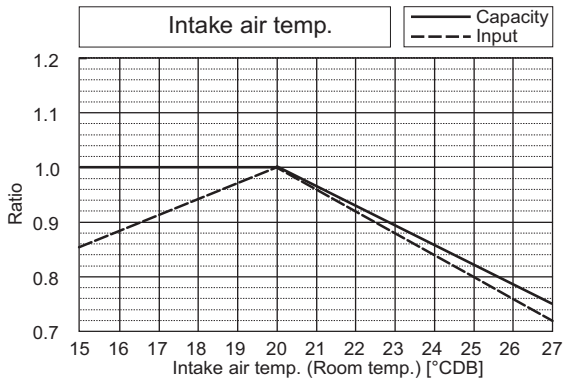
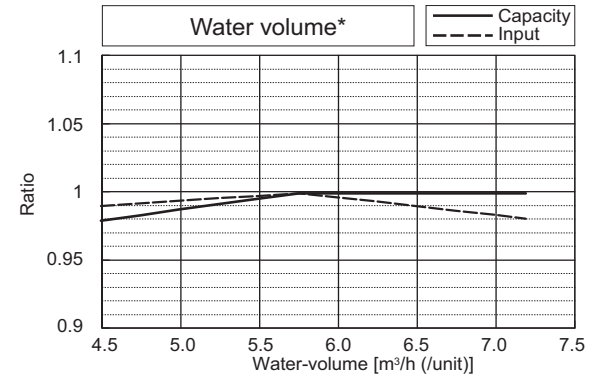
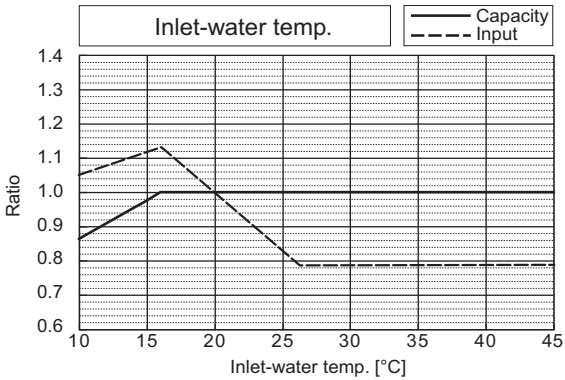

*The drawing indicates characteristic per unit.

WY

6. CAPACITY TABLES

		PQHY-P550YSHM-A	PQRY-P550YSHM-A
Nominal Cooling Capacity	kW	63.0	63.0
	BTU/h	215,000	215,000
Input	kW	13.46	13.60

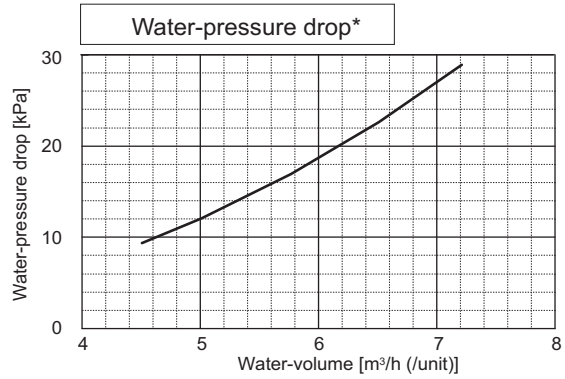
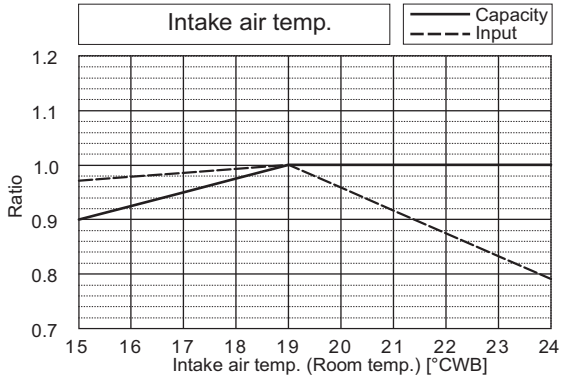
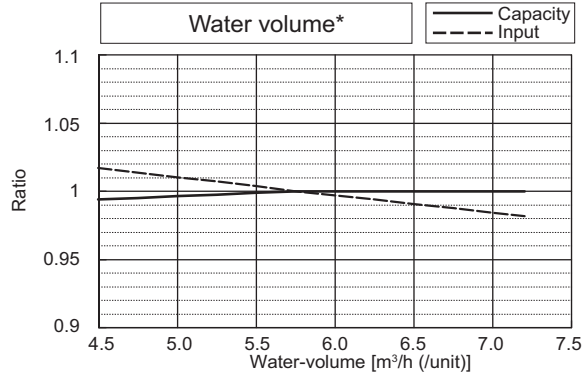
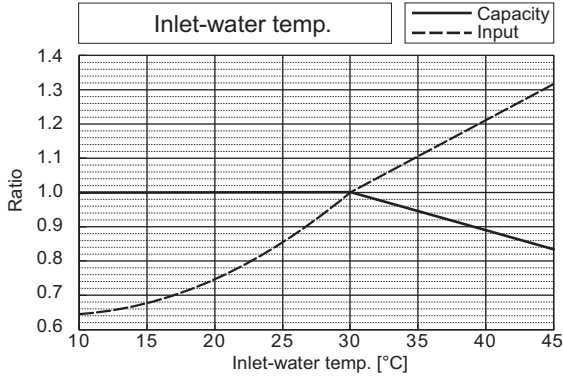

*The drawing indicates characteristic per unit.

		PQHY-P550YSHM-A	PQRY-P550YSHM-A
Nominal Heating Capacity	kW	69.0	69.0
	BTU/h	235,400	235,400
Input	kW	14.65	14.65

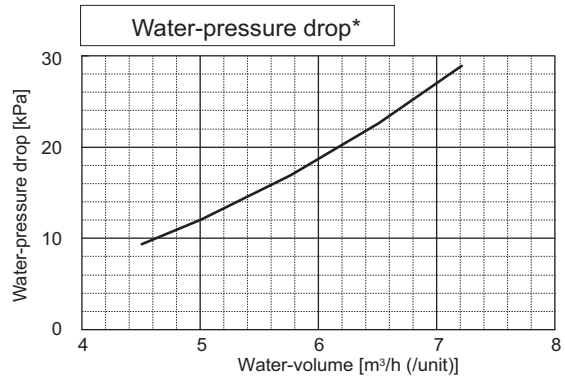
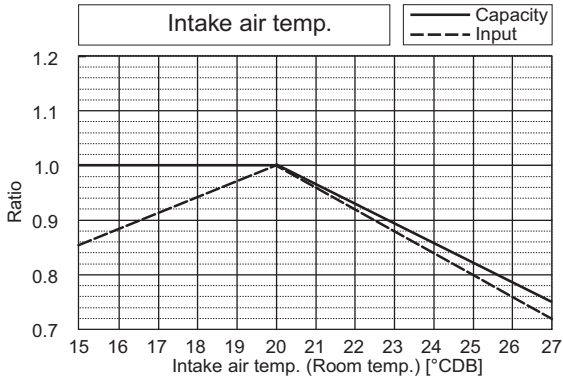
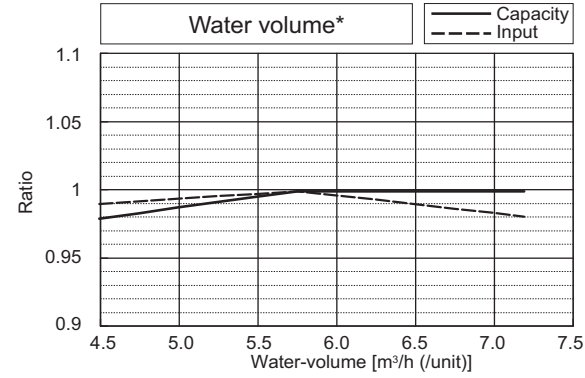
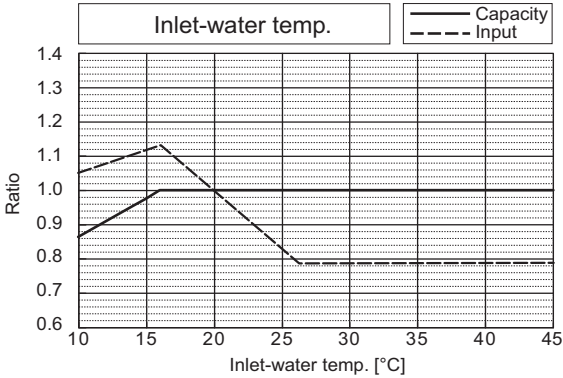

*The drawing indicates characteristic per unit.

WY

6. CAPACITY TABLES

		PQHY-P600YSHM-A	PQRY-P600YSHM-A
Nominal Cooling Capacity	kW	69.0	69.0
	BTU/h	235,400	235,400
Input	kW	15.48	15.62

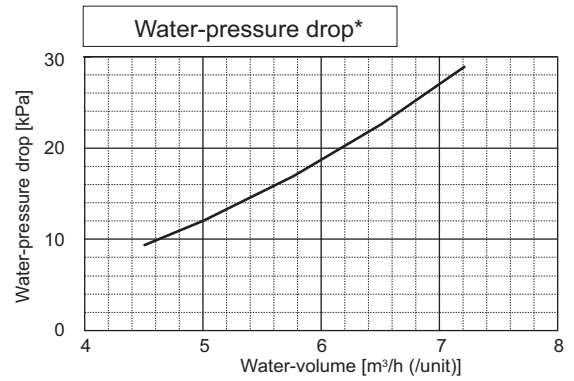
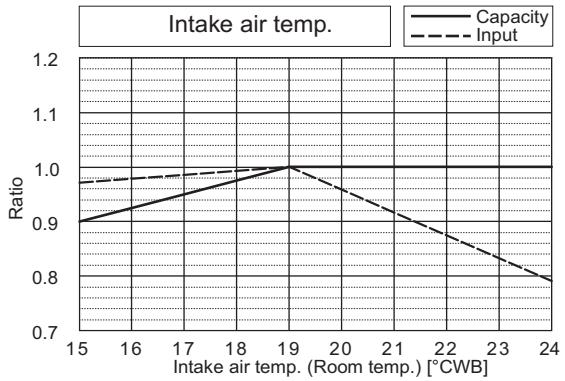
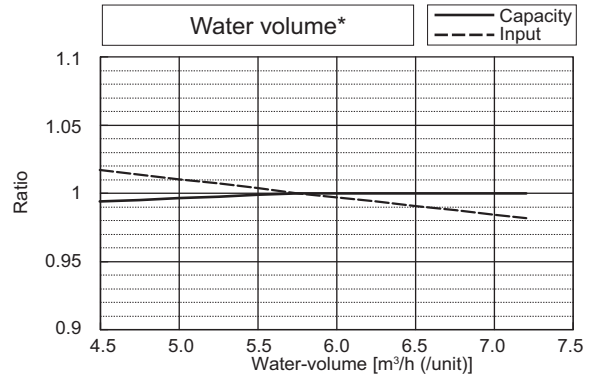
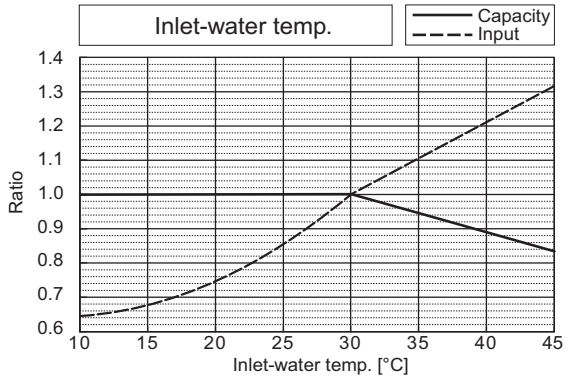

*The drawing indicates characteristic per unit.

		PQHY-P600YSHM-A	PQRY-P600YSHM-A
Nominal Heating Capacity	kW	76.5	76.5
	BTU/h	261,000	261,000
Input	kW	17.12	17.12

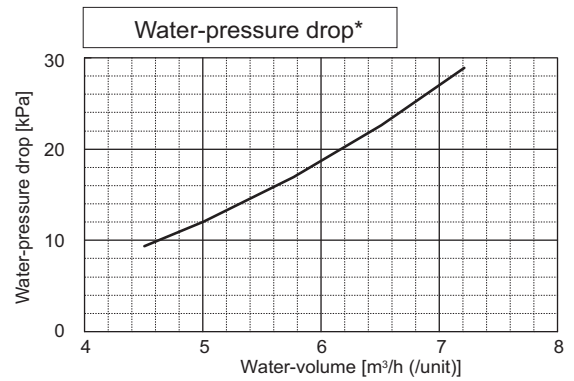
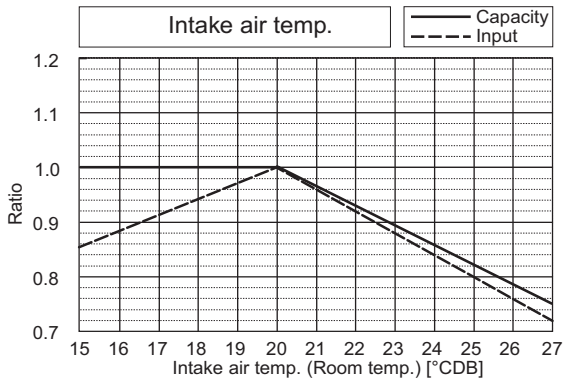
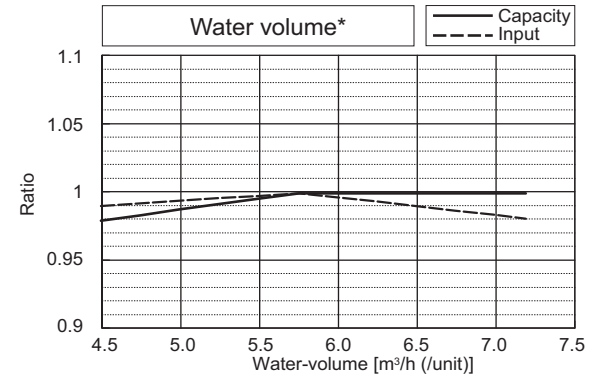
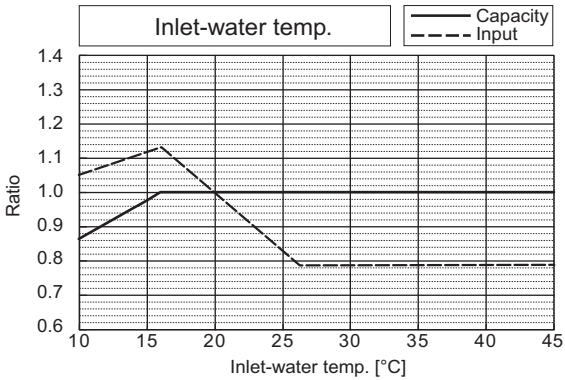

*The drawing indicates characteristic per unit.

WY

6. CAPACITY TABLES

		PQHY-P650YSHM-A
Nominal Cooling Capacity	kW	73.0
	BTU/h	249,100
Input	kW	13.96

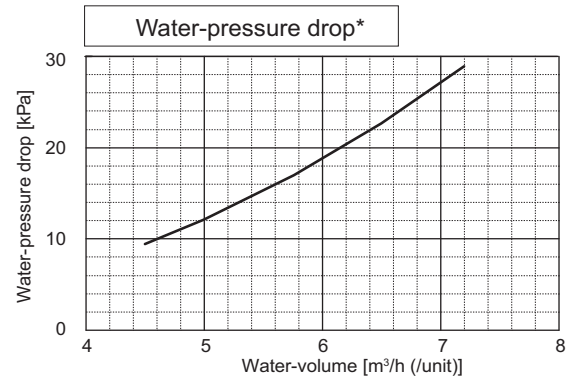
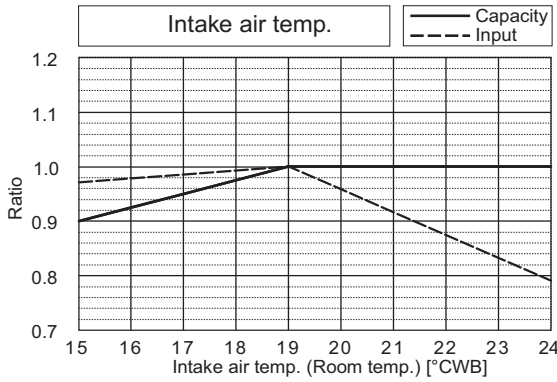
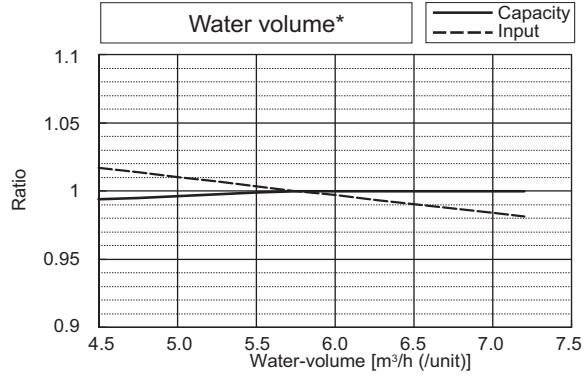
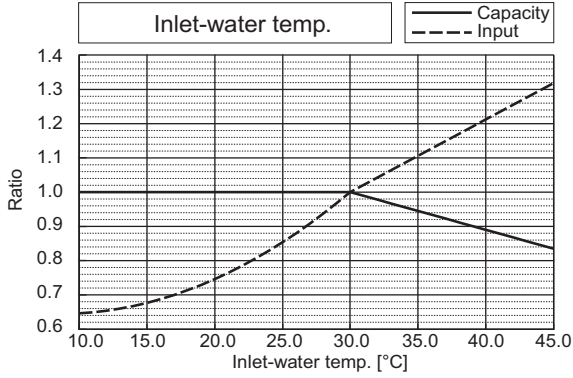

*The drawing indicates characteristic per unit.

		PQHY-P650YSHM-A
Nominal Heating Capacity	kW	81.5
	BTU/h	278,100
Input	kW	14.74

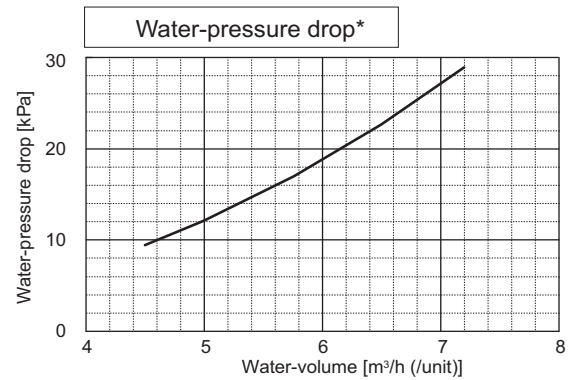
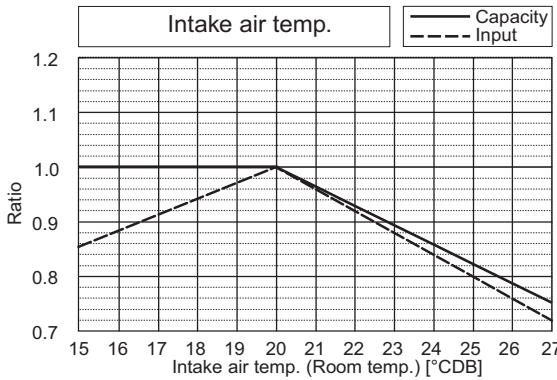
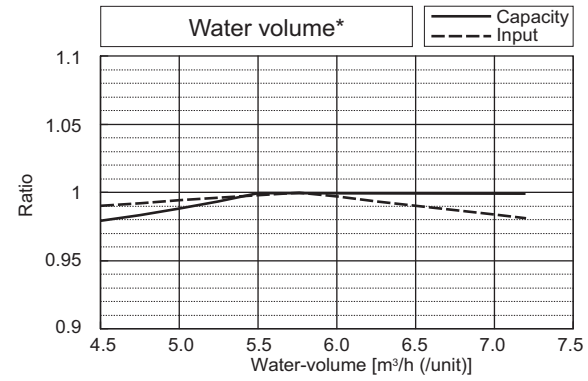
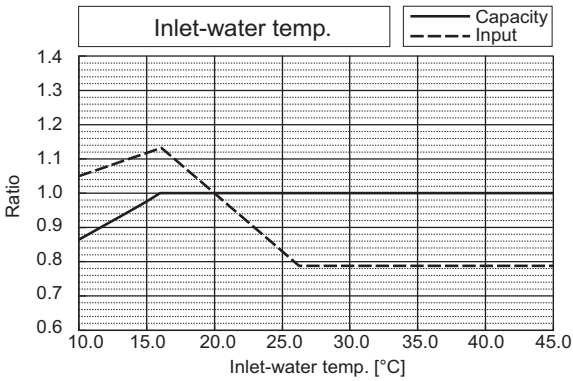

*The drawing indicates characteristic per unit.

WY

6. CAPACITY TABLES

PQHY-P700YSHM-A		
Nominal Cooling Capacity	kW	80.0
	BTU/h	273,000
Input	kW	15.58

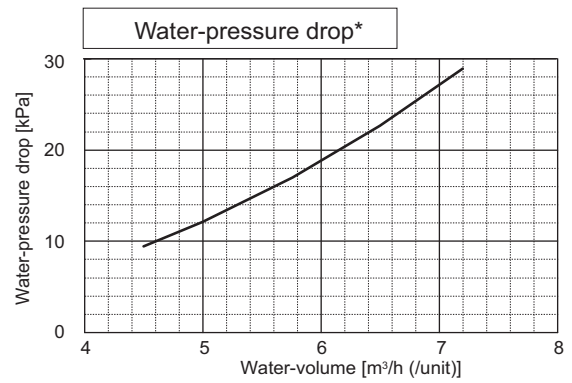
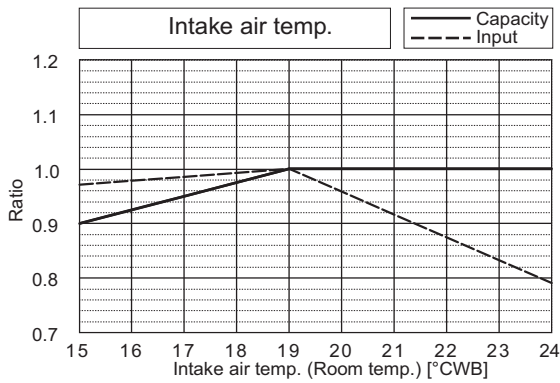
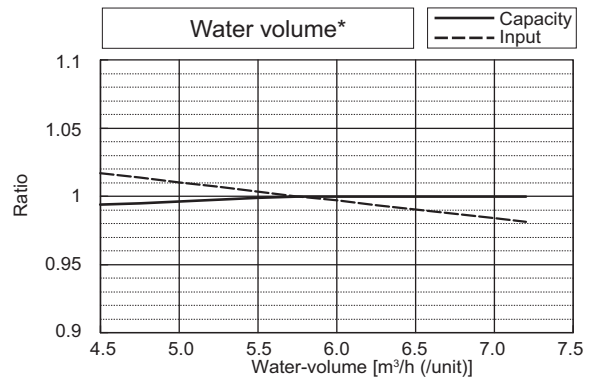
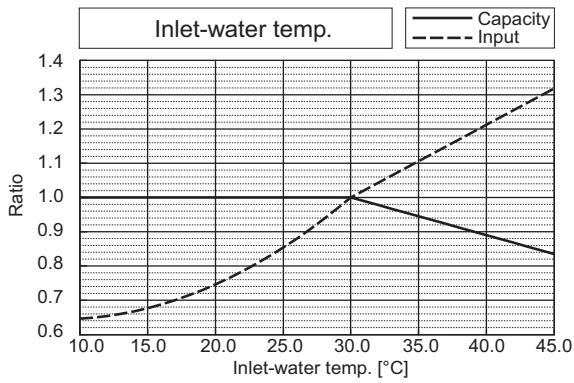

*The drawing indicates characteristic per unit.

PQHY-P700YSHM-A		
Nominal Heating Capacity	kW	88.0
	BTU/h	300,300
Input	kW	16.51

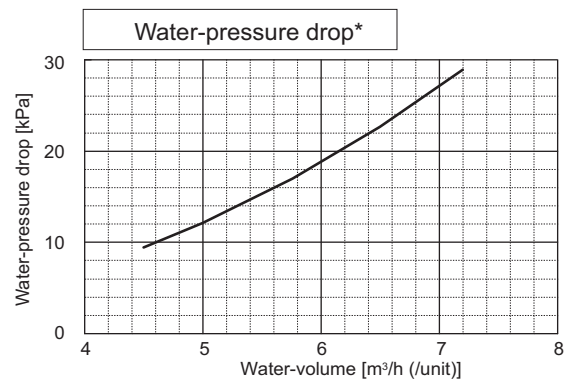
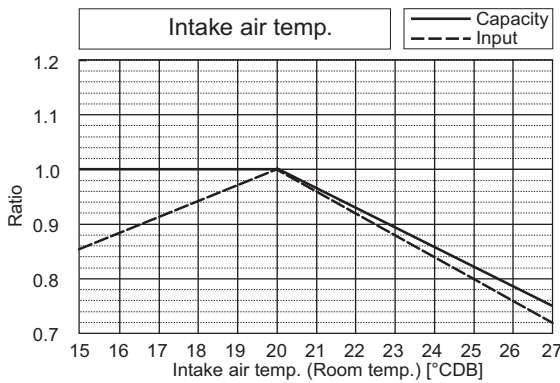
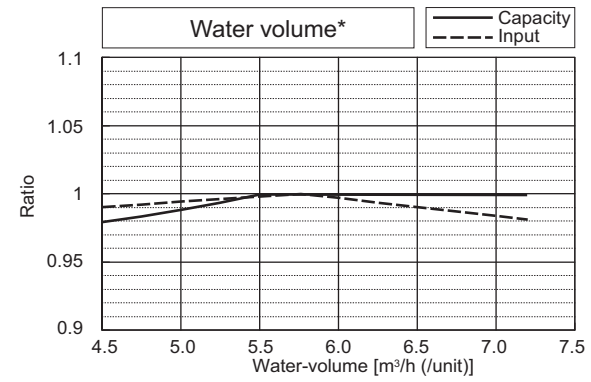
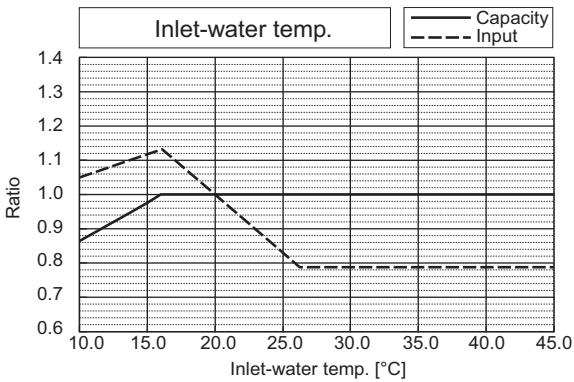

*The drawing indicates characteristic per unit.

WY

6. CAPACITY TABLES

PQHY-P750YSHM-A		
Nominal Cooling Capacity	kW	85.0
	BTU/h	290,000
Input	kW	17.19

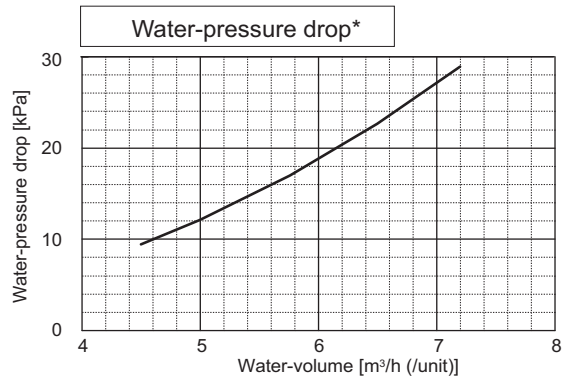
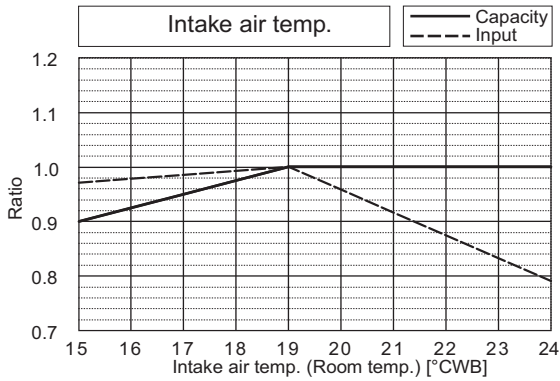
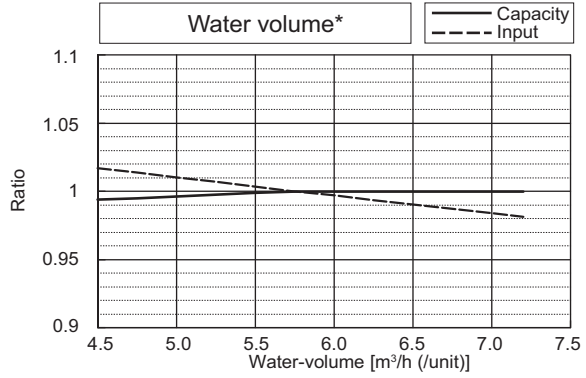
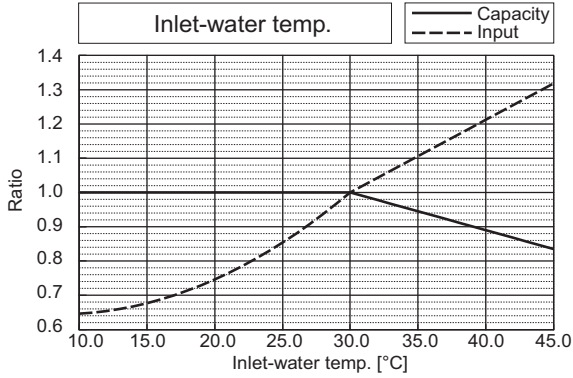

*The drawing indicates characteristic per unit.

PQHY-P750YSHM-A		
Nominal Heating Capacity	kW	95.0
	BTU/h	324,100
Input	kW	18.27

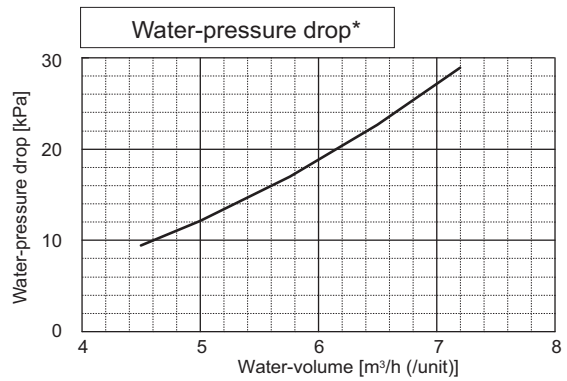
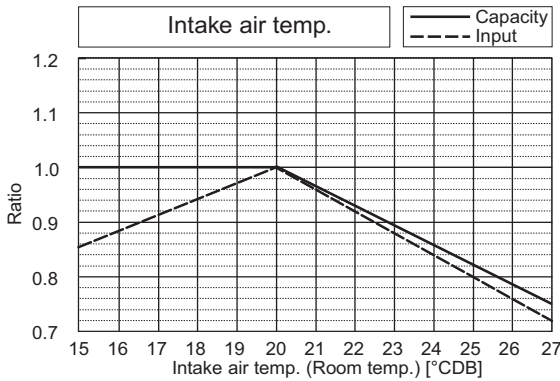
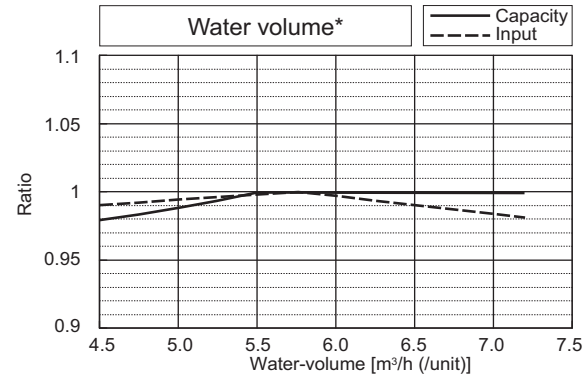
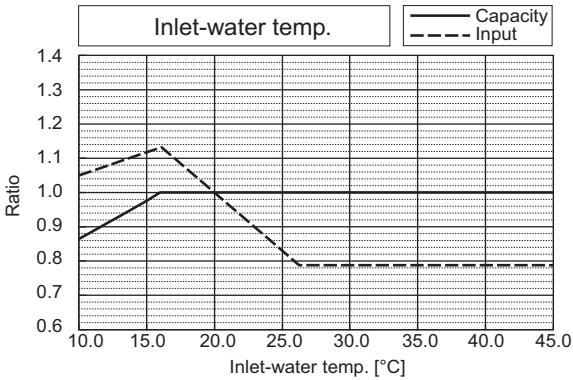

*The drawing indicates characteristic per unit.

WY

6. CAPACITY TABLES

PQHY-P800YSHM-A		
Nominal Cooling Capacity	kW	90.0
	BTU/h	307,100
Input	kW	19.18

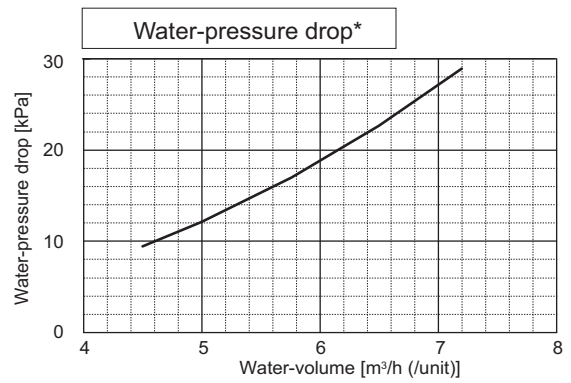
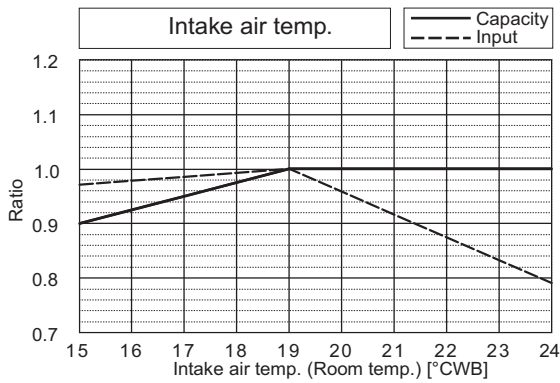
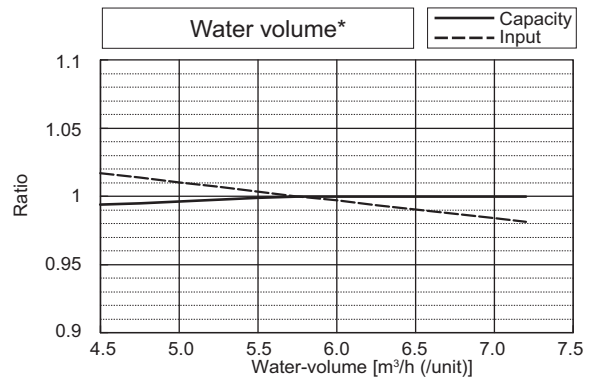
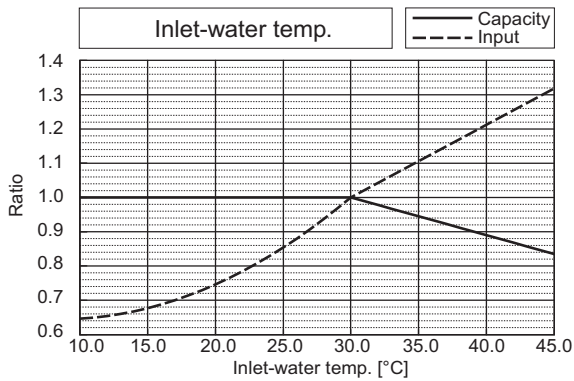

*The drawing indicates characteristic per unit.

PQHY-P800YSHM-A		
Nominal Heating Capacity	kW	100.0
	BTU/h	341,200
Input	kW	20.74

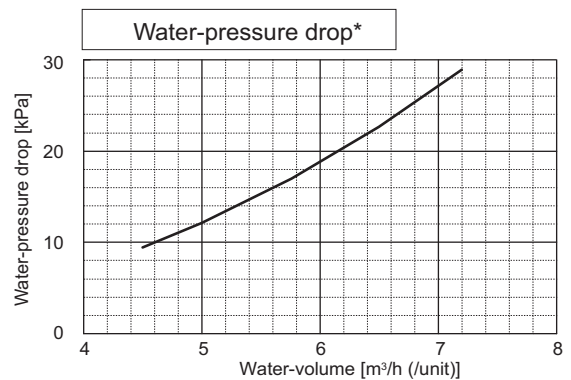
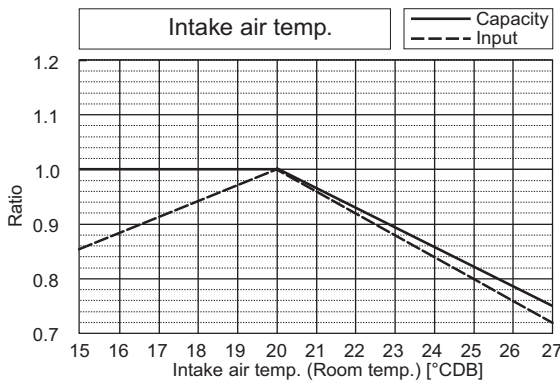
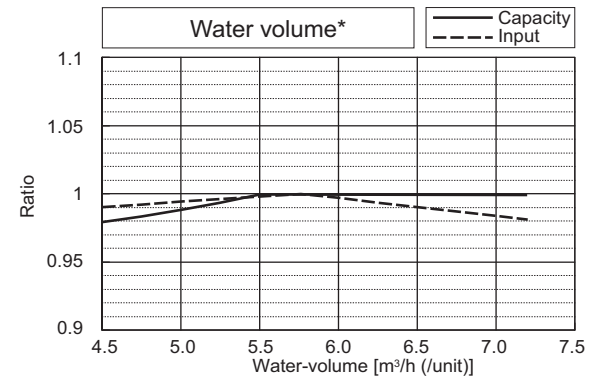
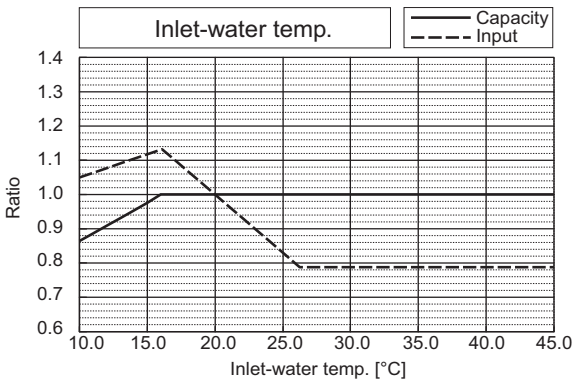

*The drawing indicates characteristic per unit.

6. CAPACITY TABLES

PQHY-P850YSHM-A		
Nominal Cooling Capacity	kW	96.0
	BTU/h	327,600
Input	kW	21.20

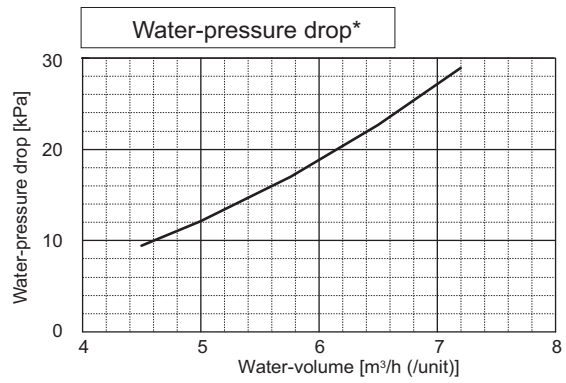
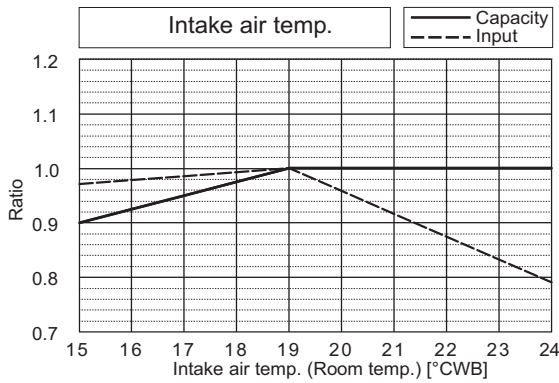
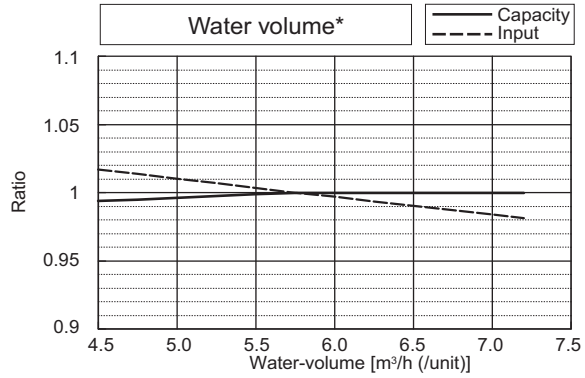
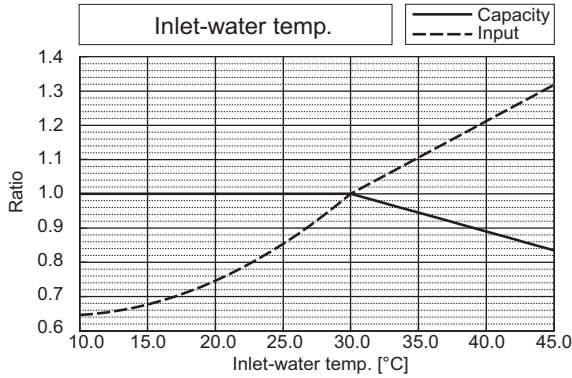

*The drawing indicates characteristic per unit.

PQHY-P850YSHM-A		
Nominal Heating Capacity	kW	108.0
	BTU/h	368,500
Input	kW	23.21

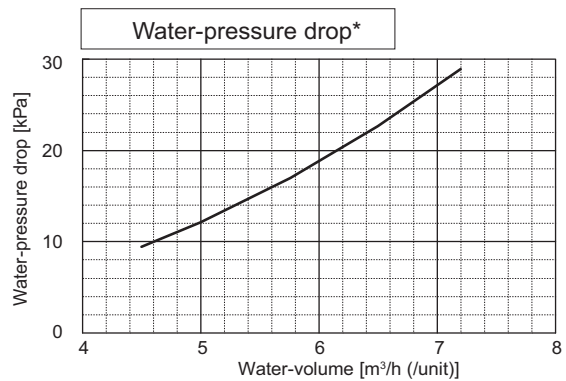
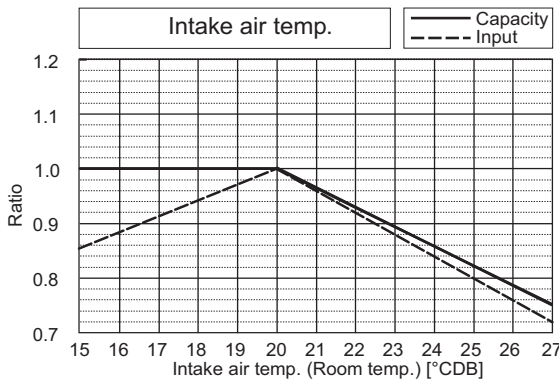
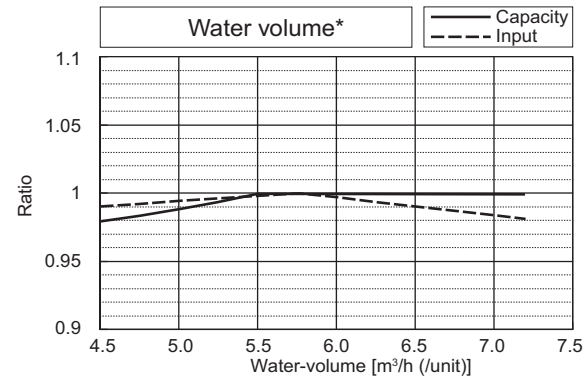
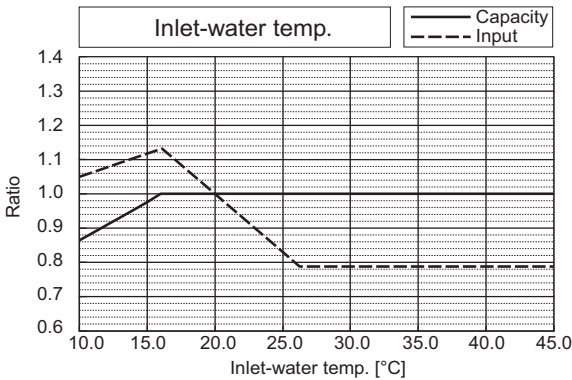

*The drawing indicates characteristic per unit.

WY

6. CAPACITY TABLES

PQHY-P900YSHM-A		
Nominal Cooling Capacity	kW	101.0
	BTU/h	344,600
Input	kW	23.22

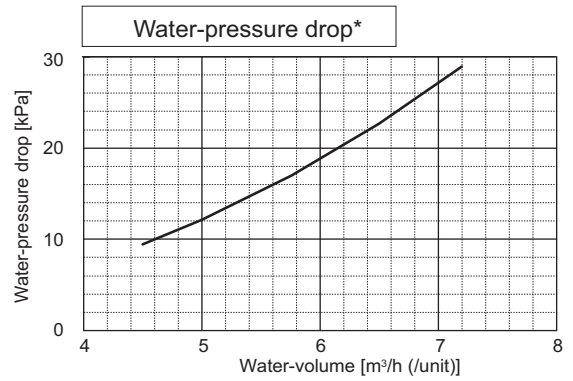
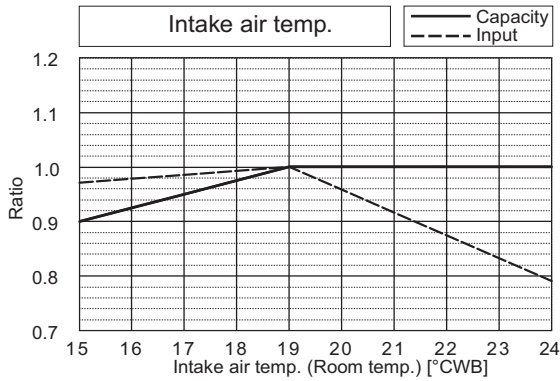
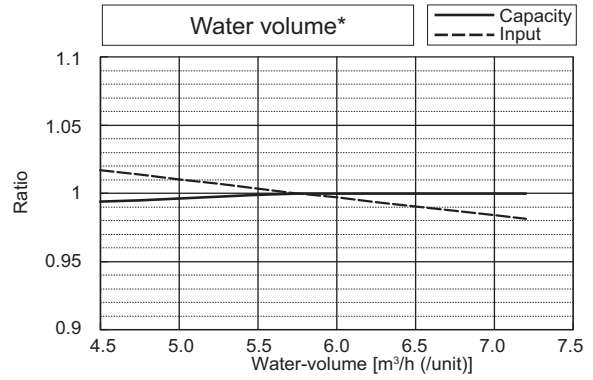
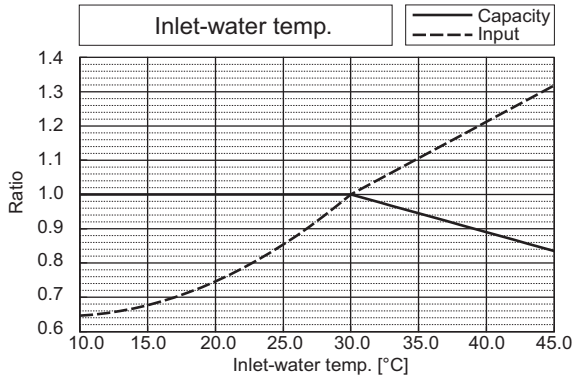

*The drawing indicates characteristic per unit.

PQHY-P900YSHM-A		
Nominal Heating Capacity	kW	113.0
	BTU/h	385,600
Input	kW	25.67

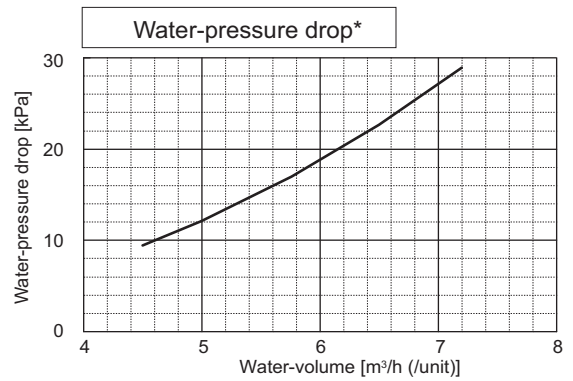
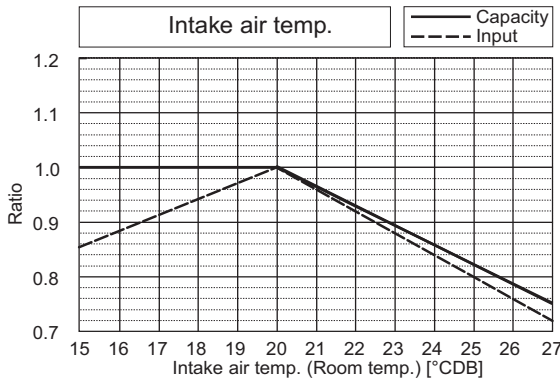
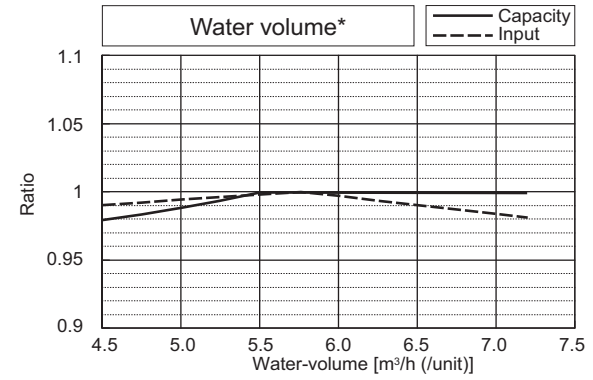
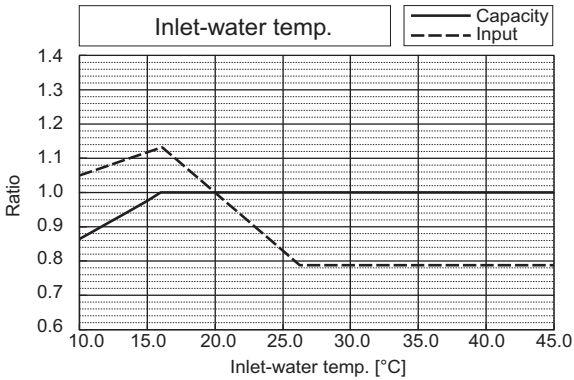

*The drawing indicates characteristic per unit.

WY

6-2. Correction by total indoor

CITY MULTI system have different capacities and inputs when many combinations of indoor units with different total capacities are connected. Using following tables, the maximum capacity can be found to ensure the system is installed with enough capacity for a particular application.

PQHY-P200YHM-A

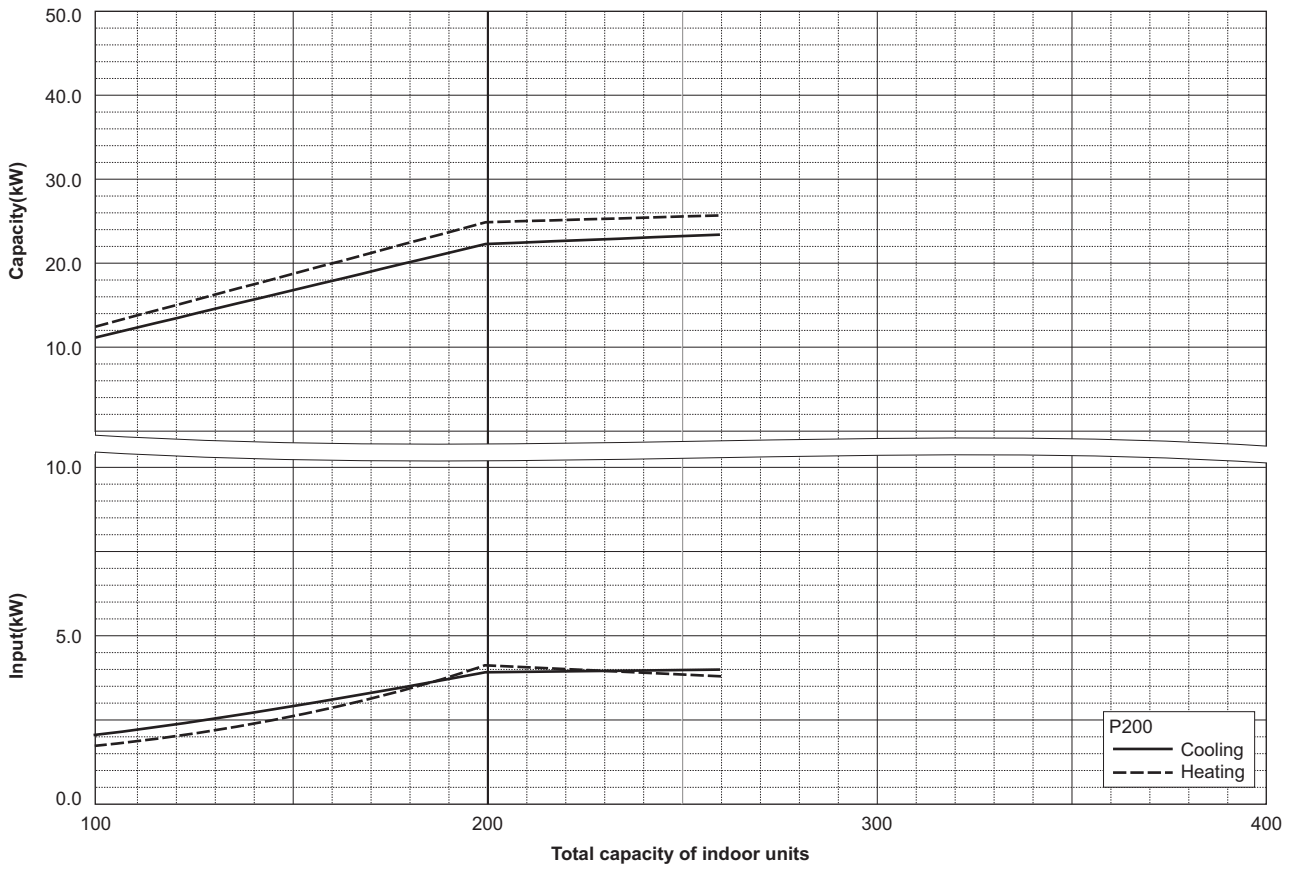

PQHY-P250YHM-A

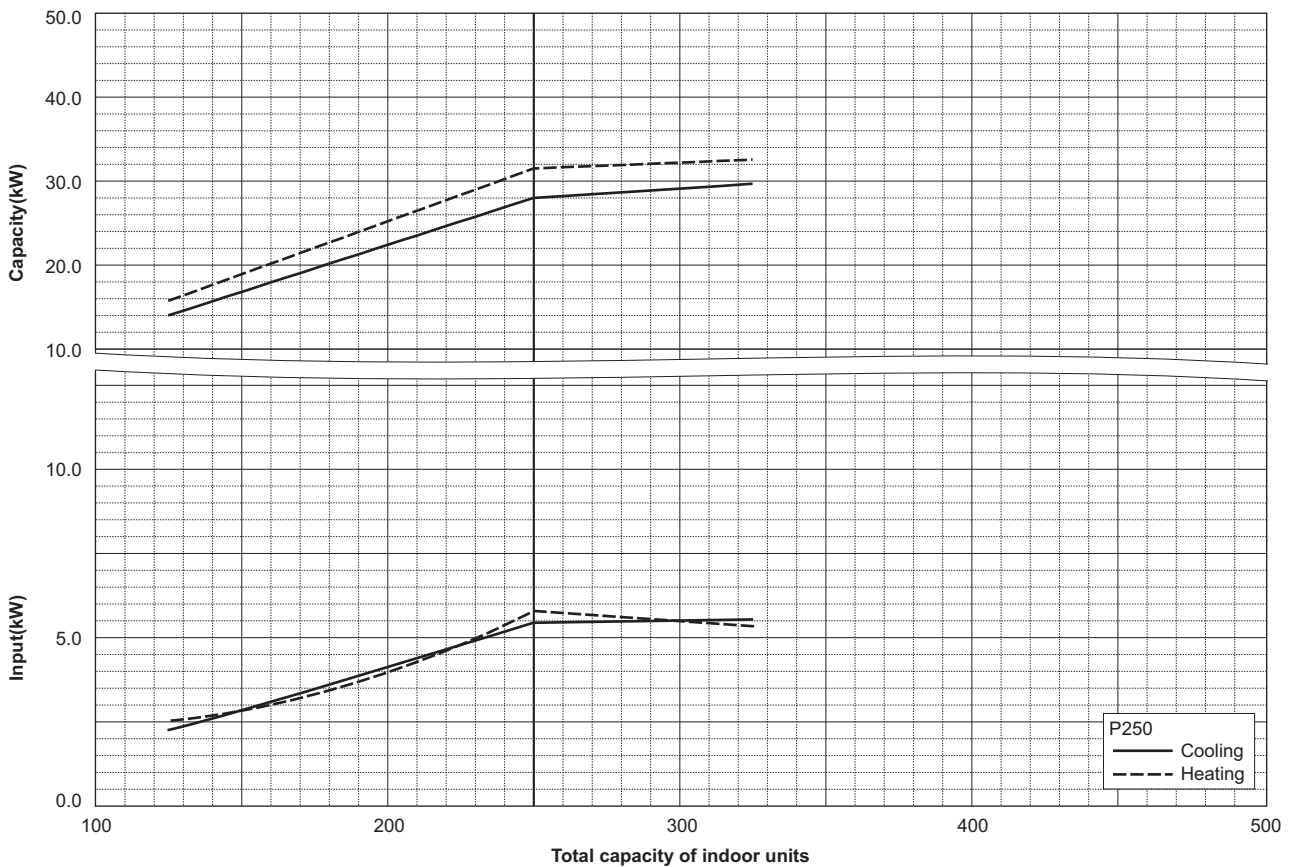

WY

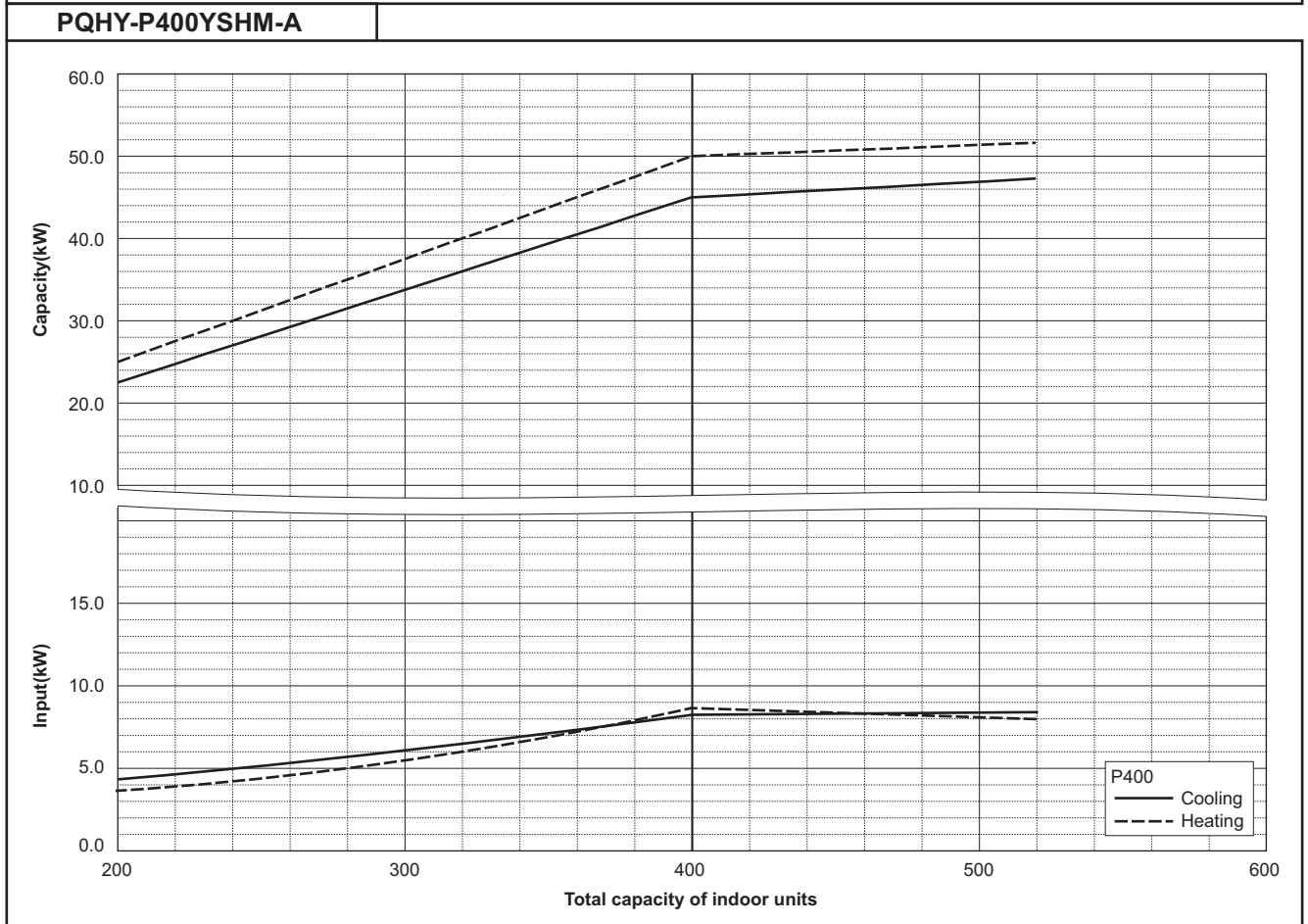
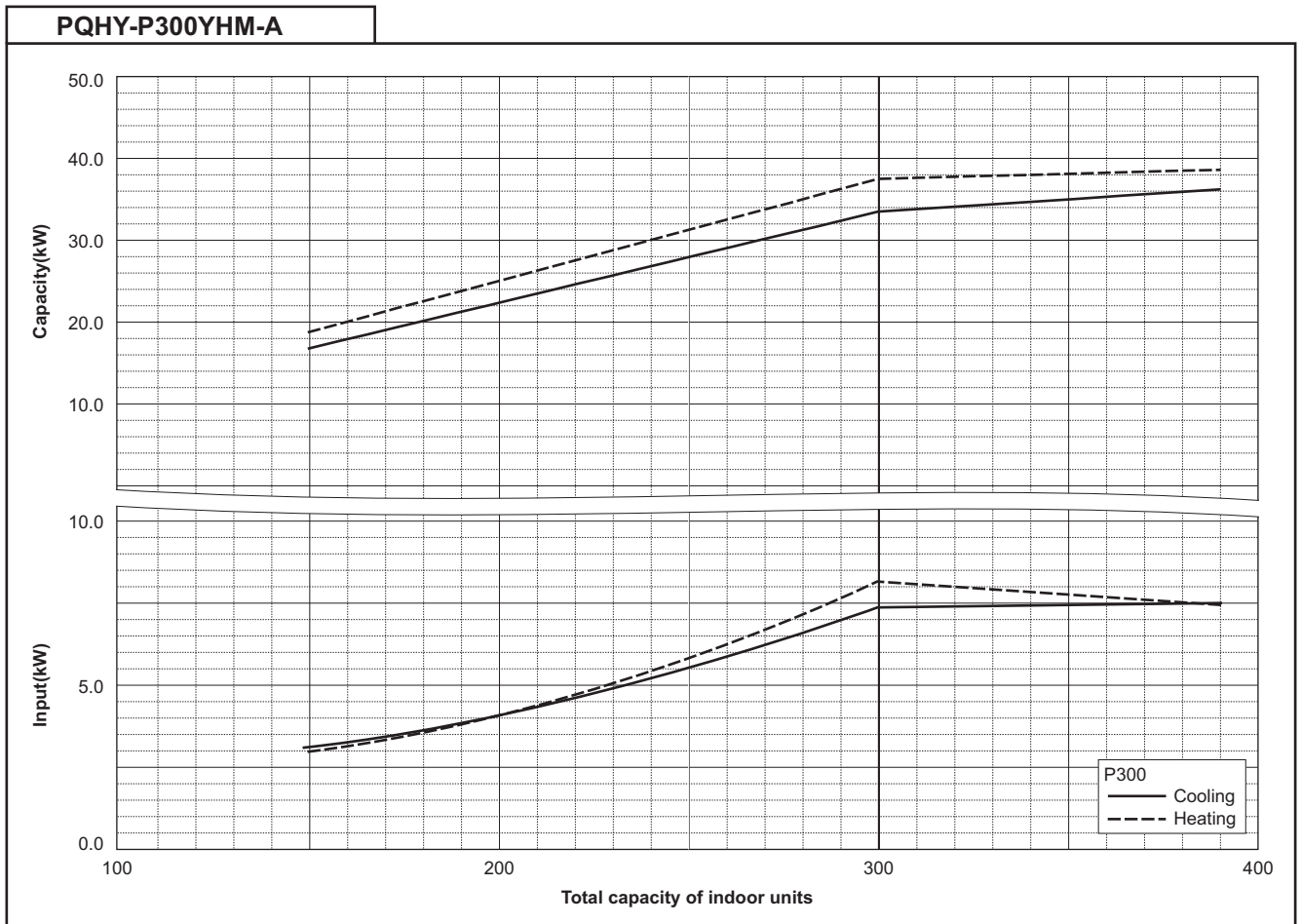

WY

PQHY-P450YSHM-A

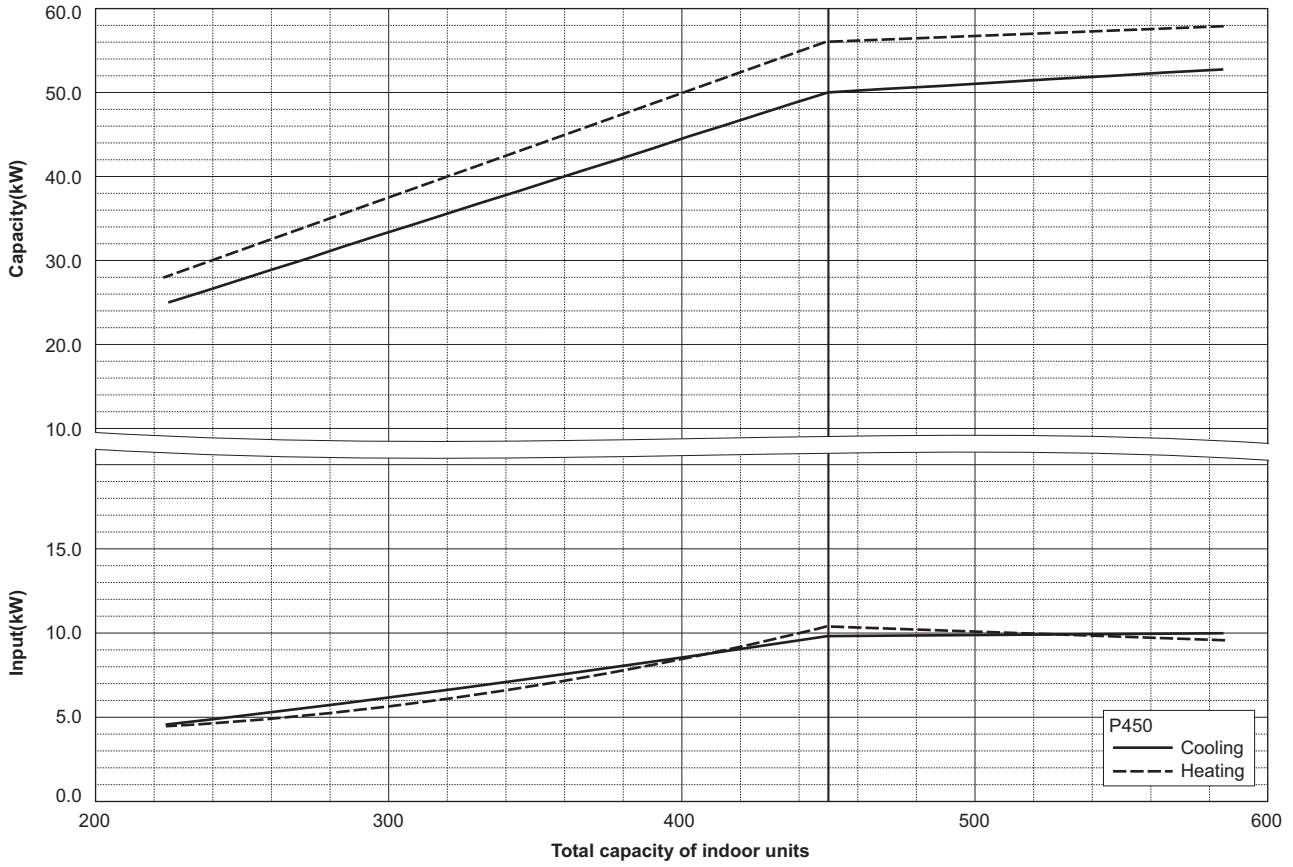

PQHY-P500YSHM-A

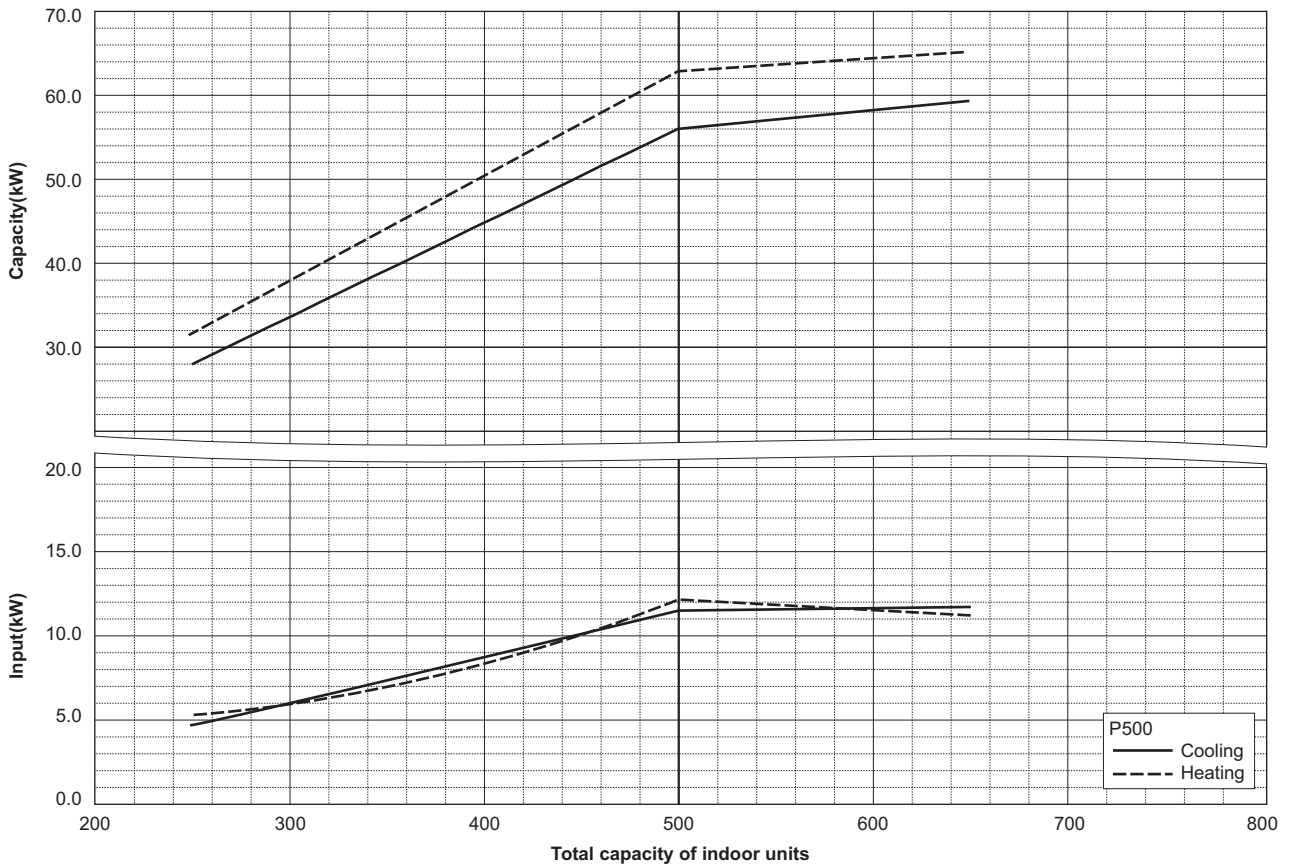

WY

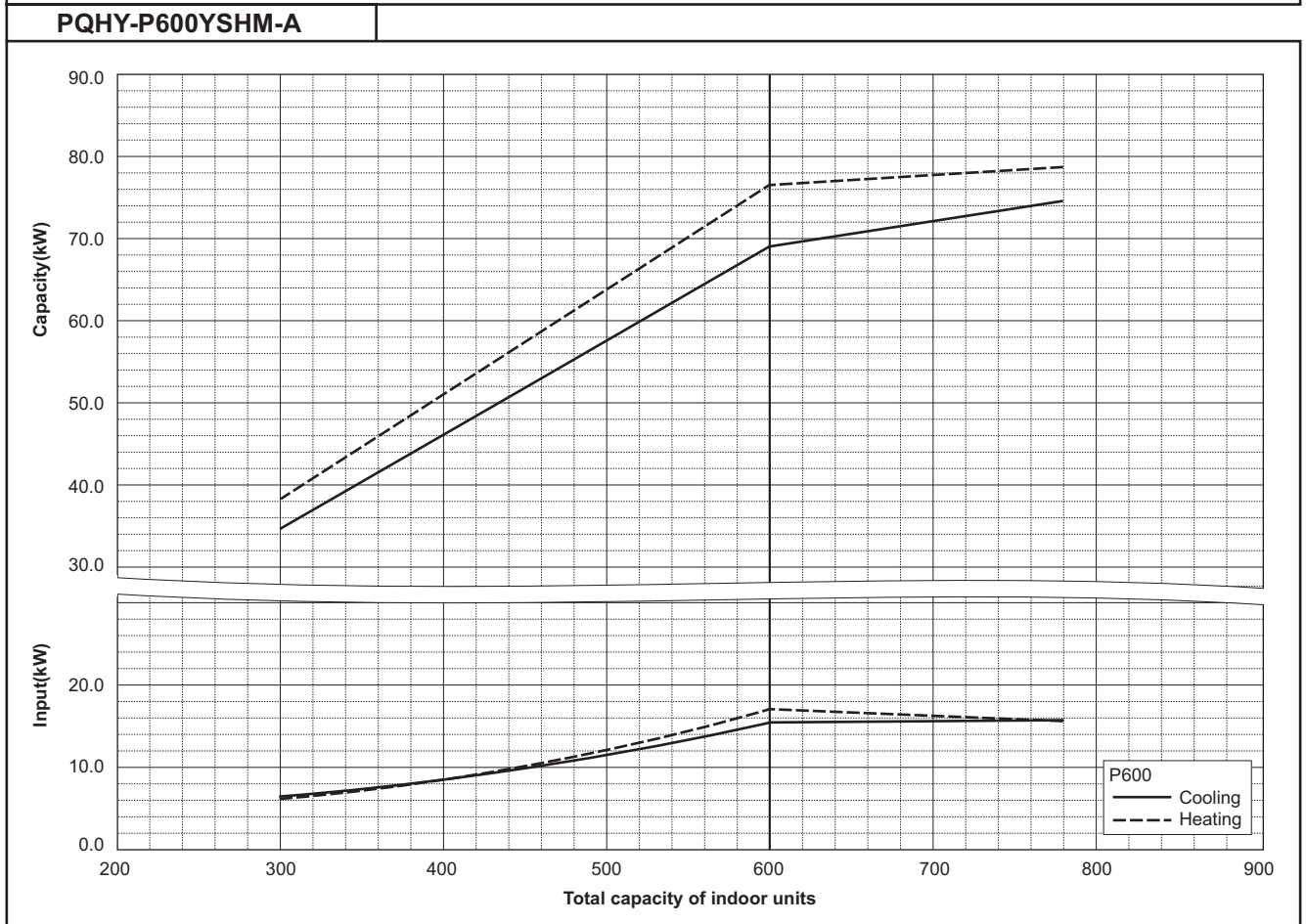
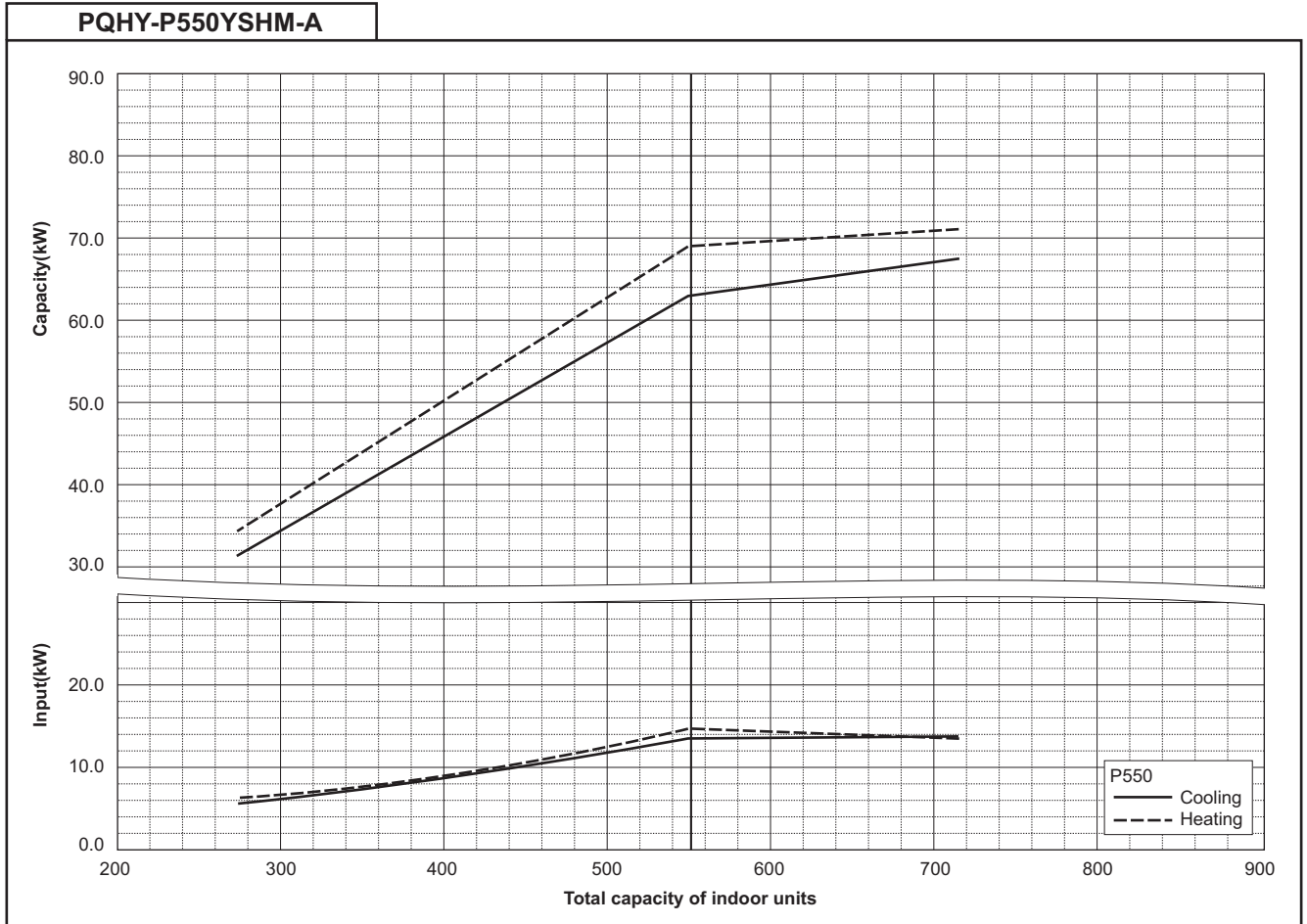

WY

WY

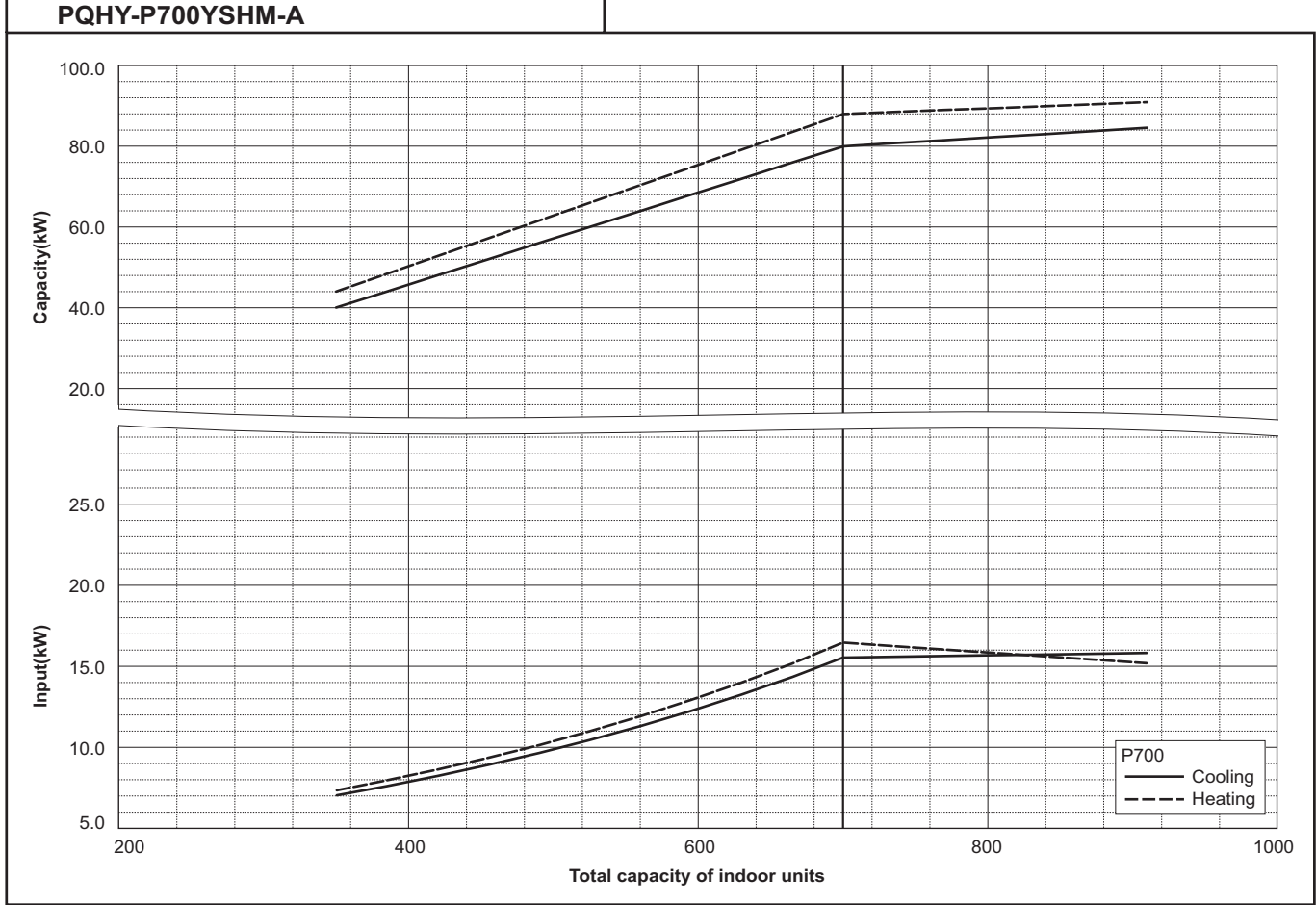
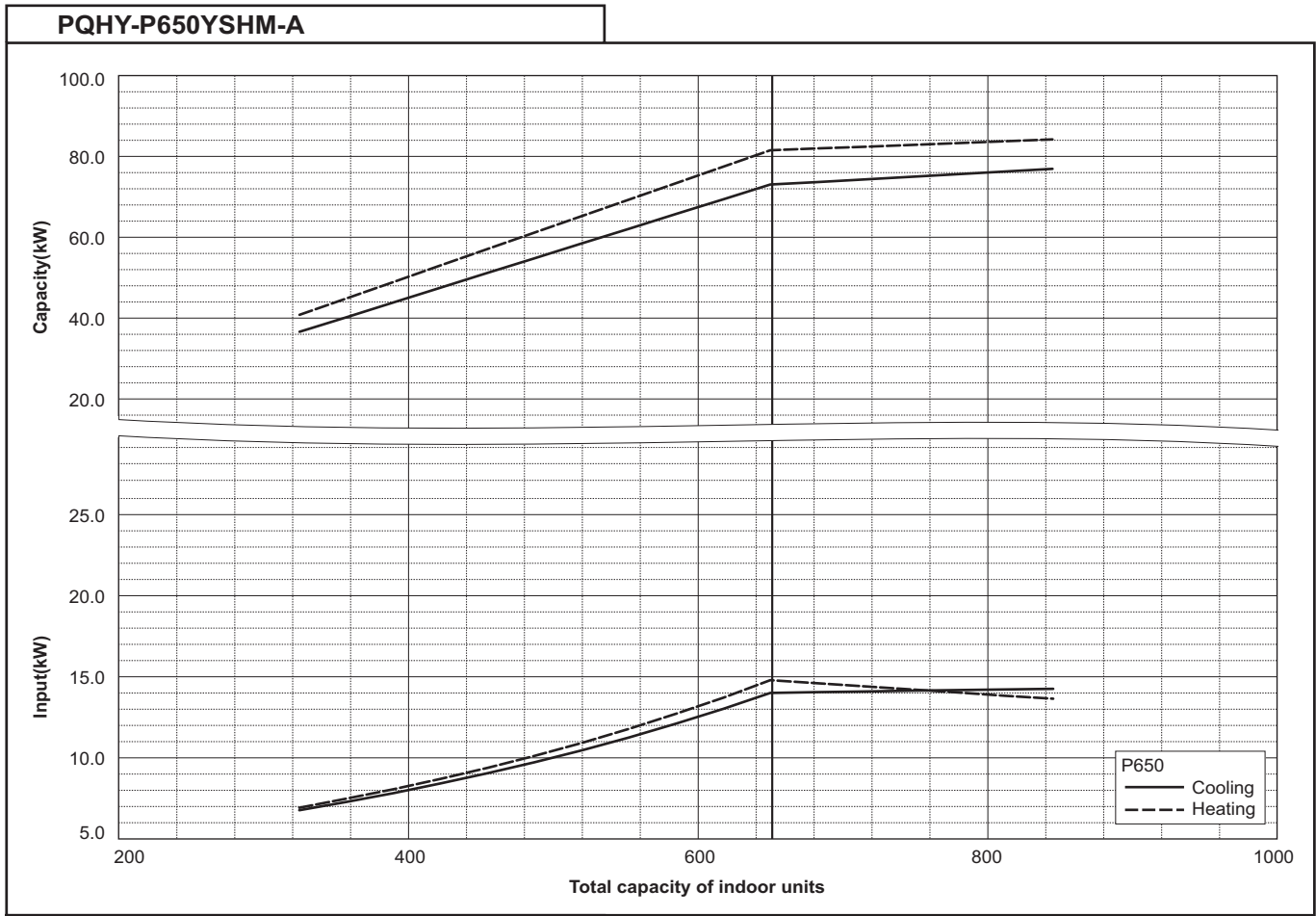

6. CAPACITY TABLES

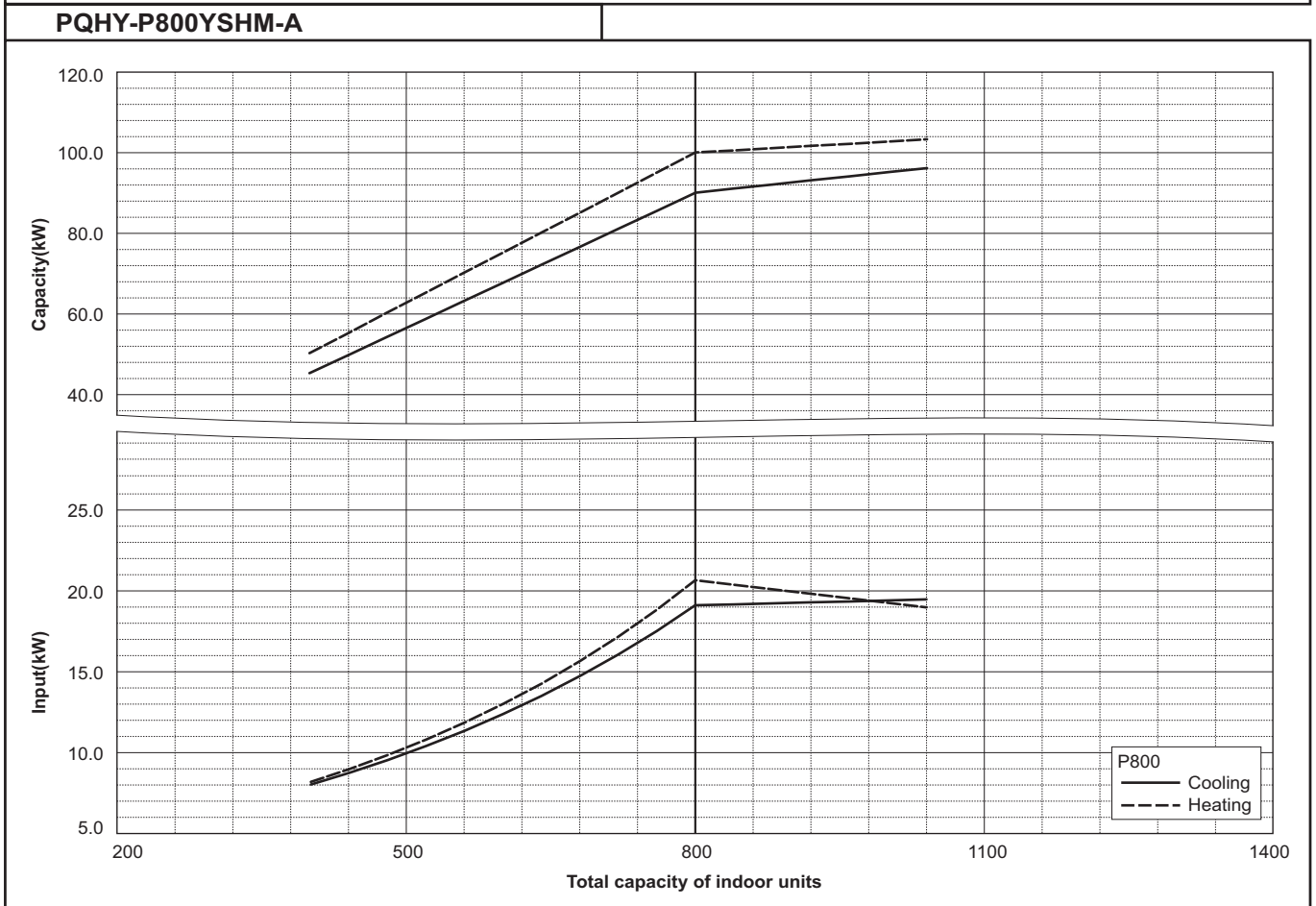
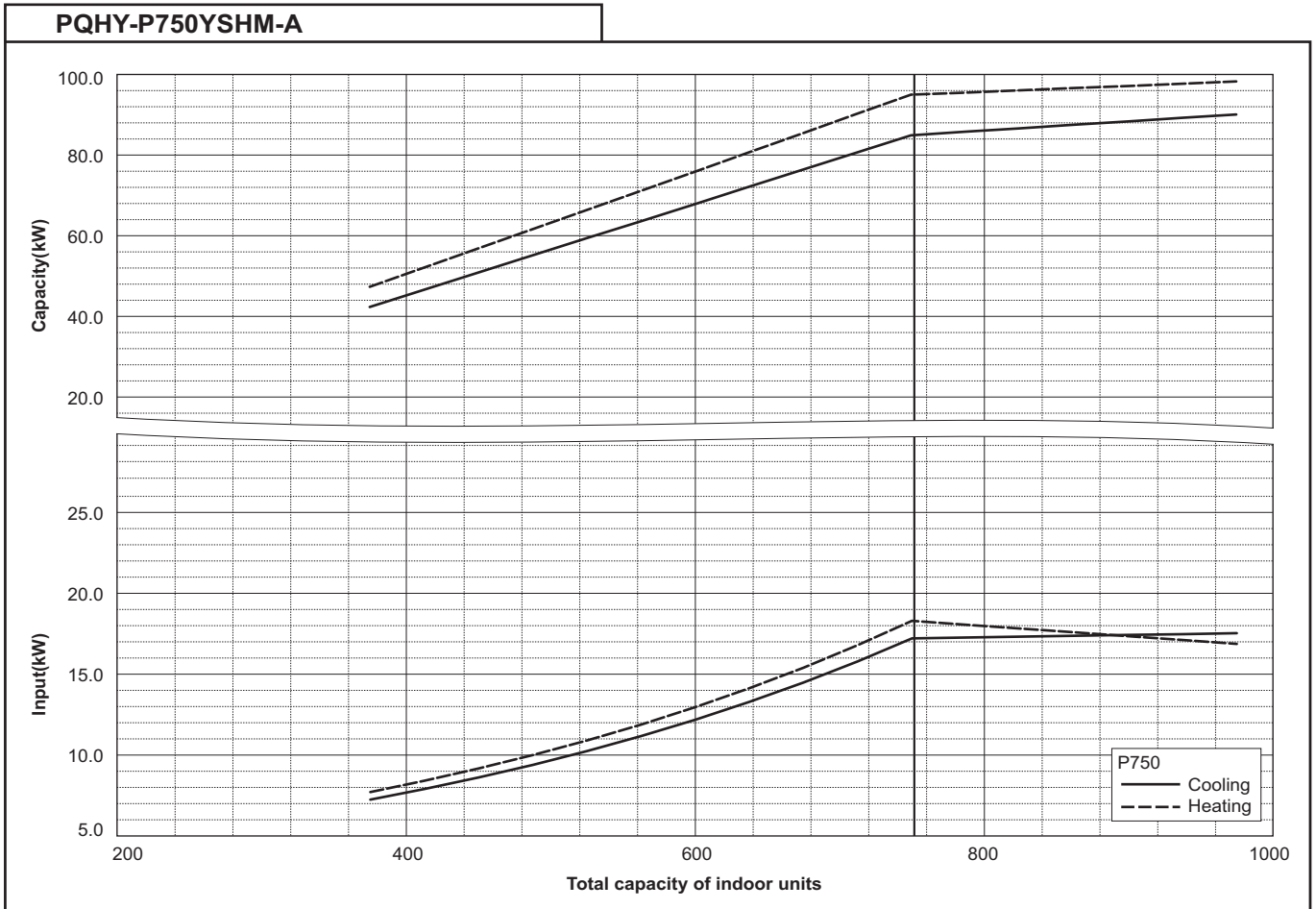

6. CAPACITY TABLES

PQHY-P850YSHM-A

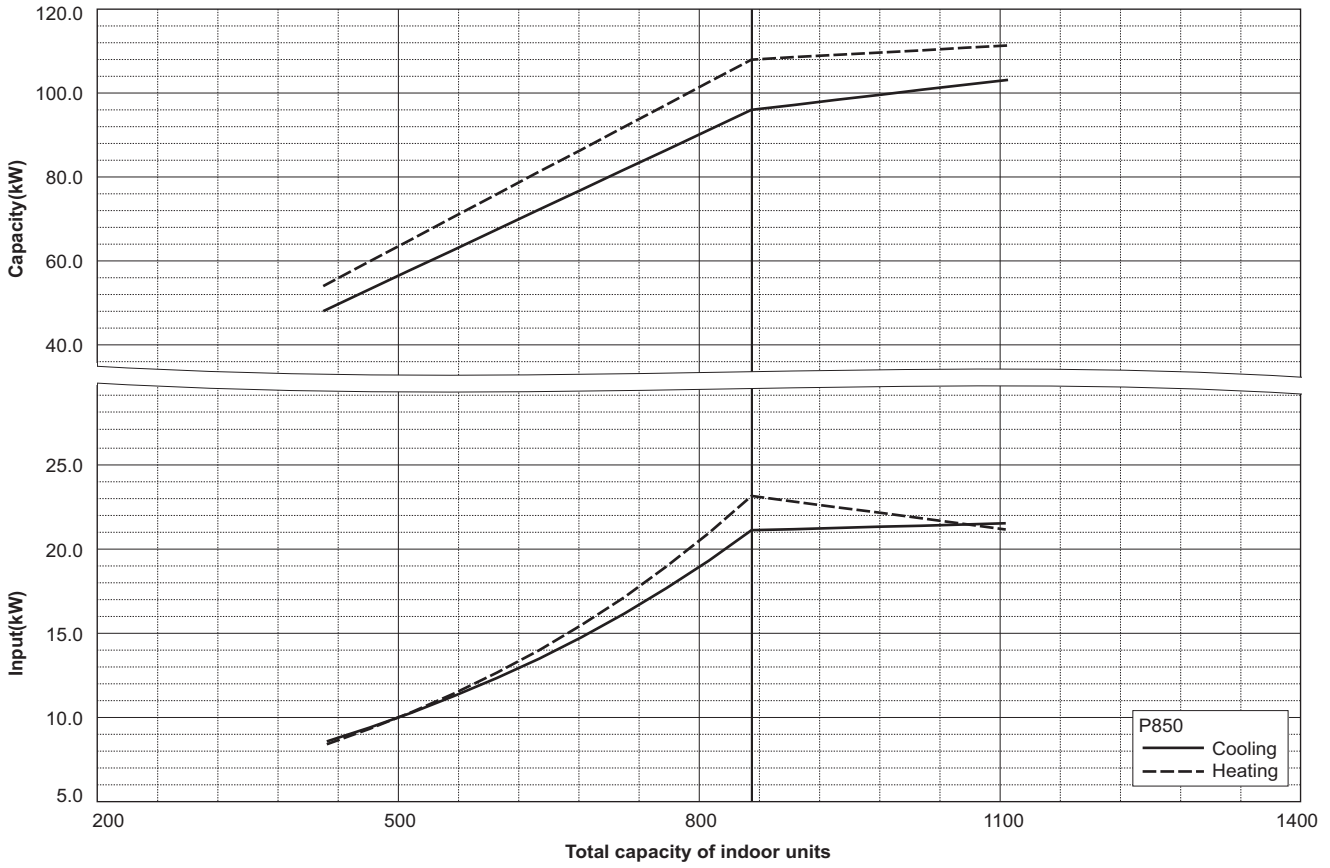

PQHY-P900YSHM-A

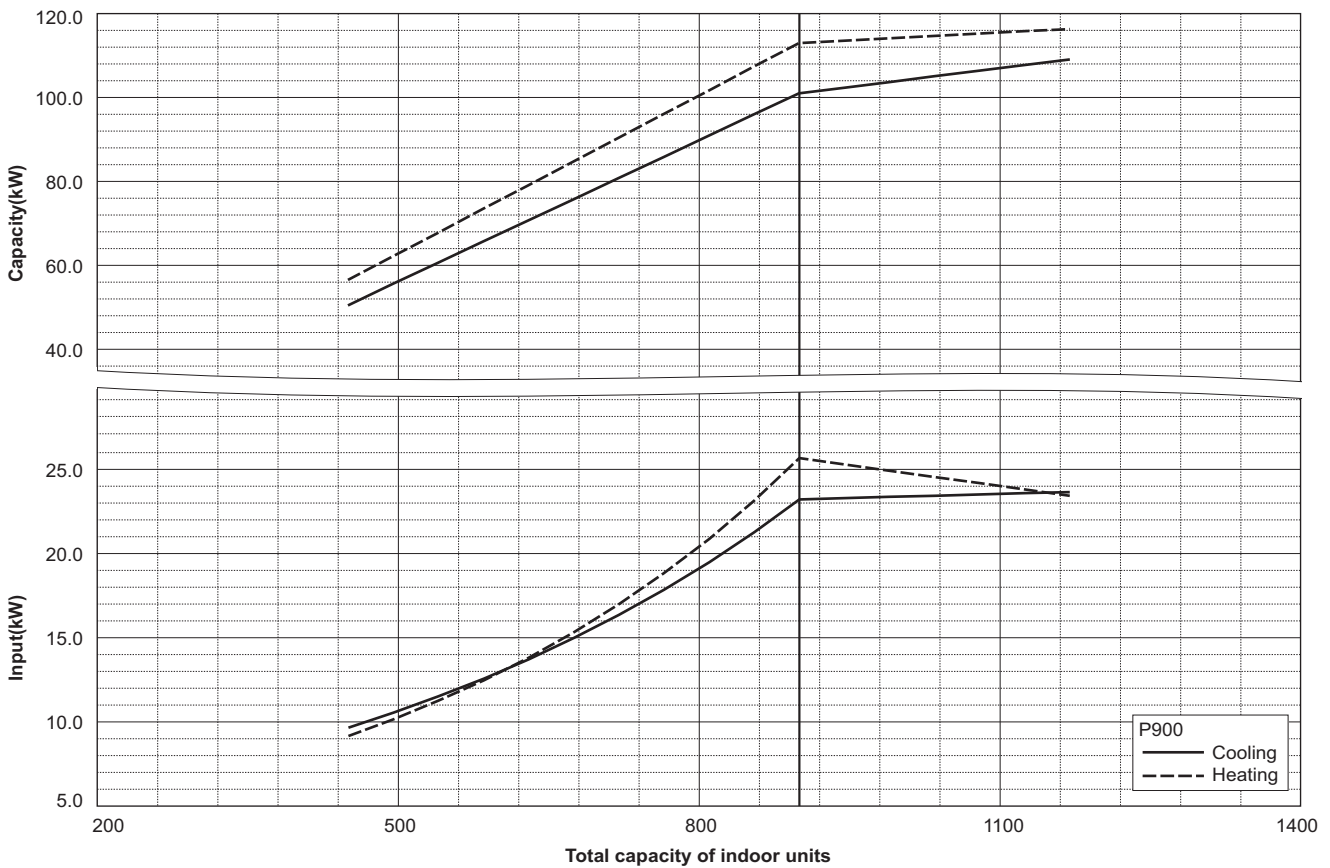

WY

6-3. Correction by refrigerant piping length

CITY MULTI systems can have extended piping lengths if certain limitations are followed, but cooling/heating capacity could be reduced. Using following correction factor by equivalent piping length shown at 6-3-1 and 6-3-2, capacity can be found. 6-3-3 shows how to obtain the equivalent piping length.

6-3-1. Cooling capacity correction

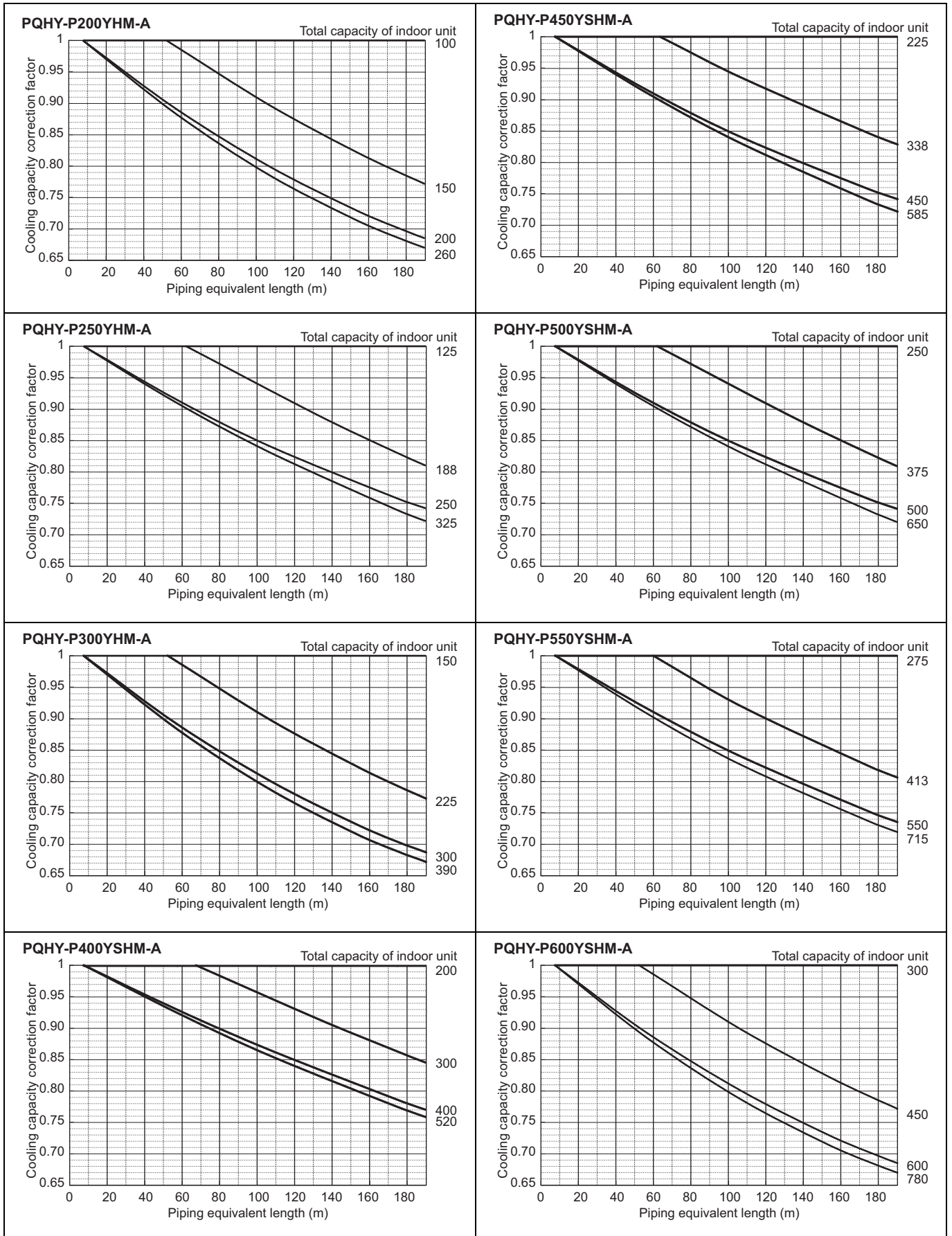

6. CAPACITY TABLES

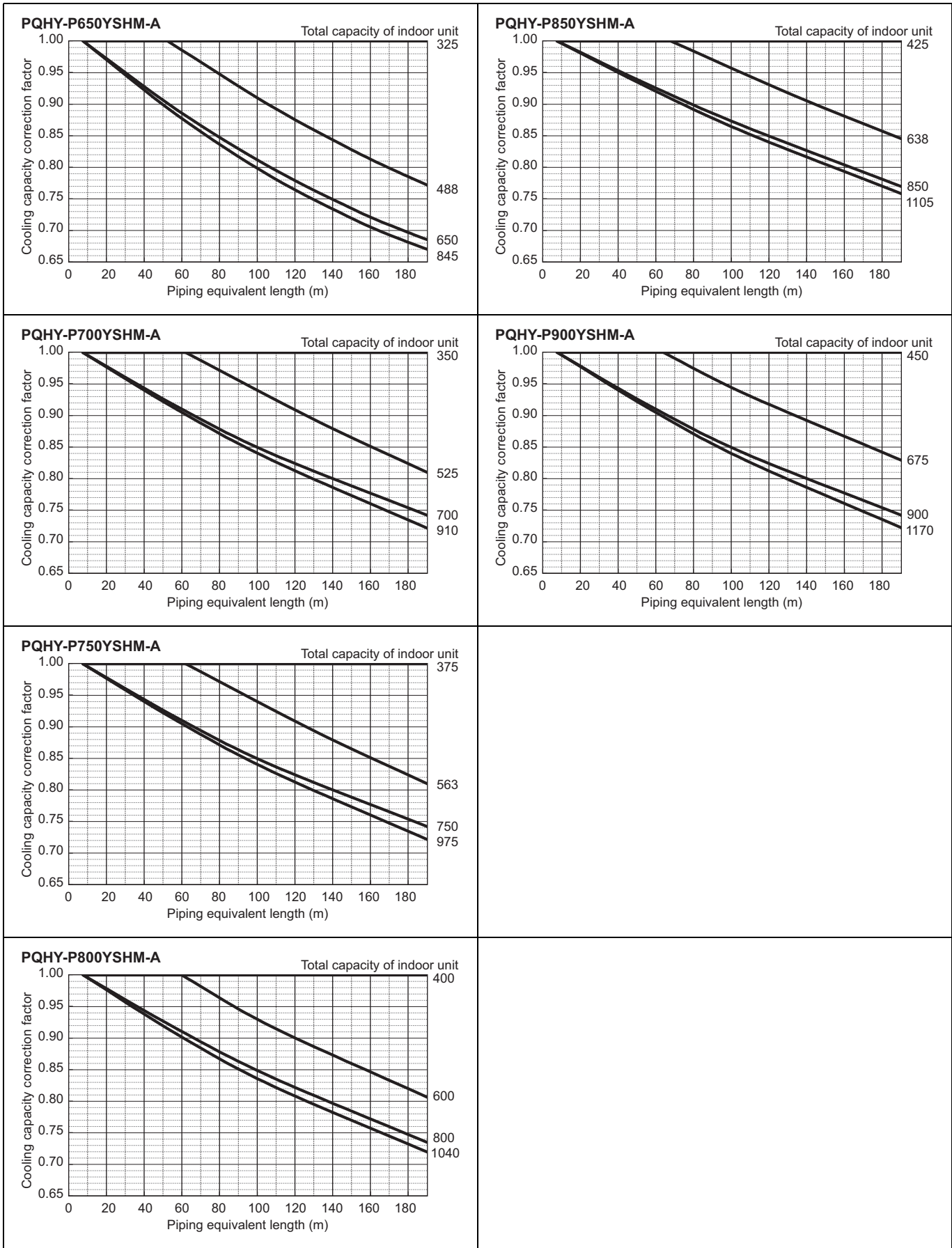

WY

6-3-2. Heating capacity correction

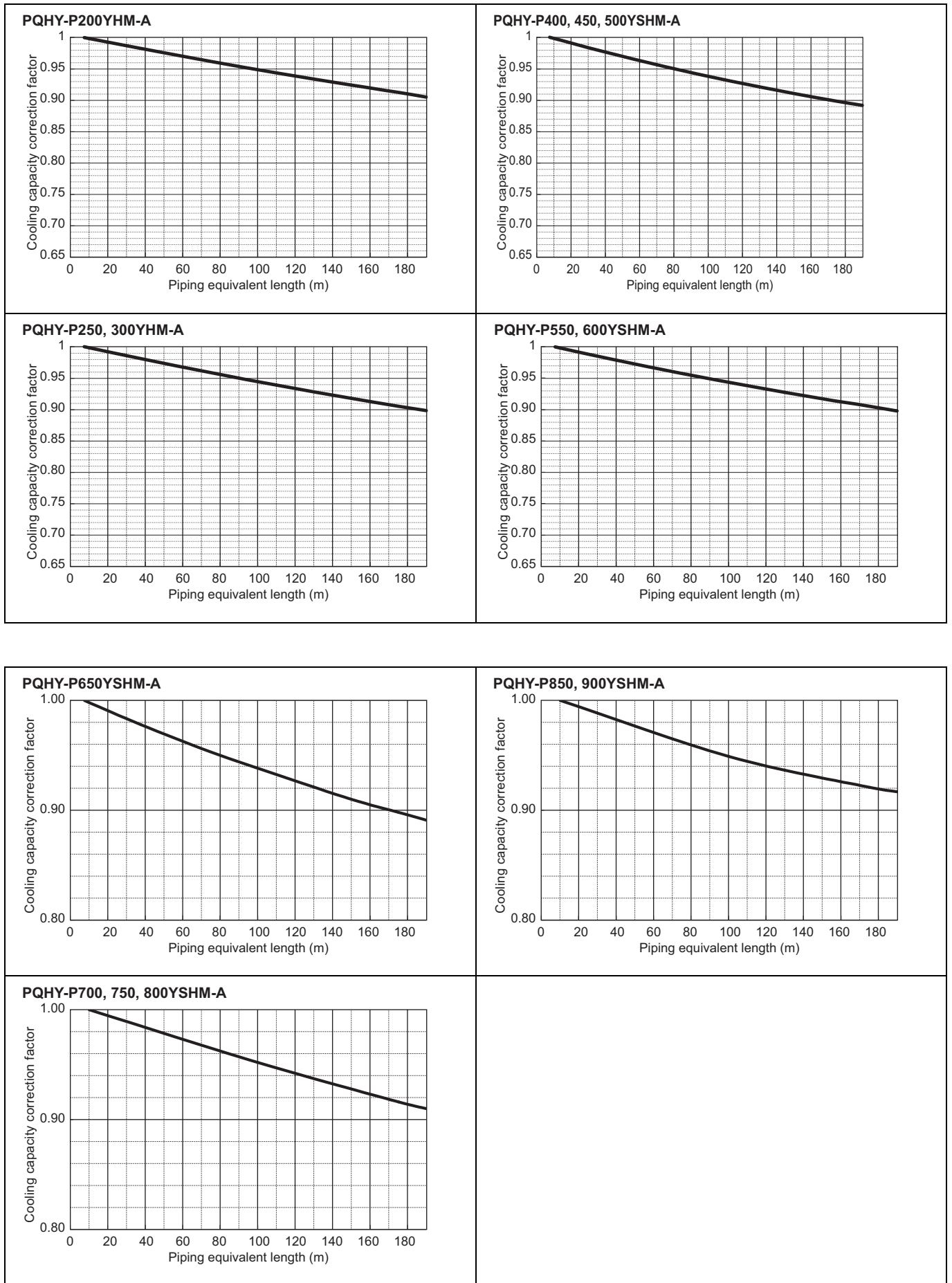

WY

6-3-3. How to obtain the equivalent piping length**1 PQHY-P200YHM**

Equivalent length = (Actual piping length to the farthest indoor unit) + (0.35 x number of bends in the piping) m

2 PQHY-P250, 300YHM

Equivalent length = (Actual piping length to the farthest indoor unit) + (0.42 x number of bends in the piping) m

3 PQHY-P400, 450, 500, 550, 600, 650YSHM

Equivalent length = (Actual piping length to the farthest indoor unit) + (0.50 x number of bends in the piping) m

4 PQHY-P700, 750, 800YSHM

Equivalent length = (Actual piping length to the farthest indoor unit) + (0.70 x number of bends in the piping) m

5 PQHY-P850, 900YSHM

Equivalent length = (Actual piping length to the farthest indoor unit) + (0.80 x number of bends in the piping) m

6-4. Operation temperature range

• Cooling

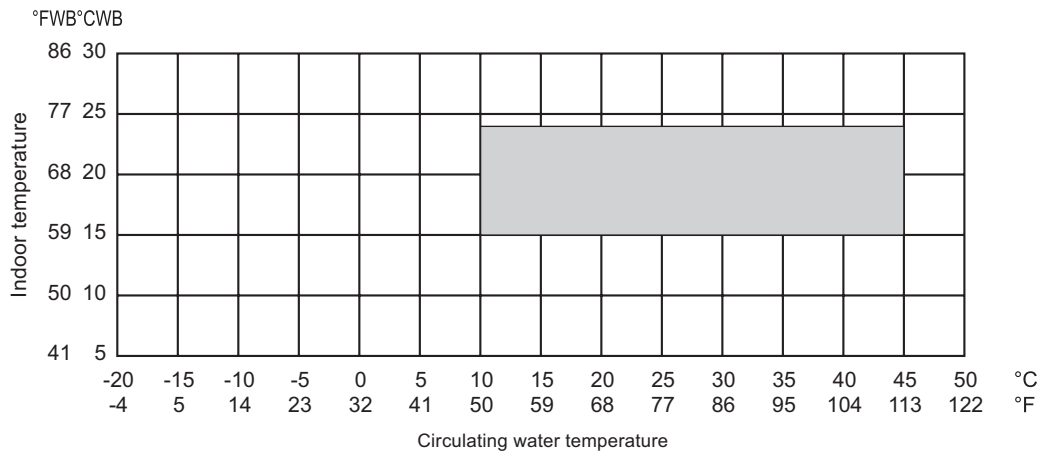

• Heating

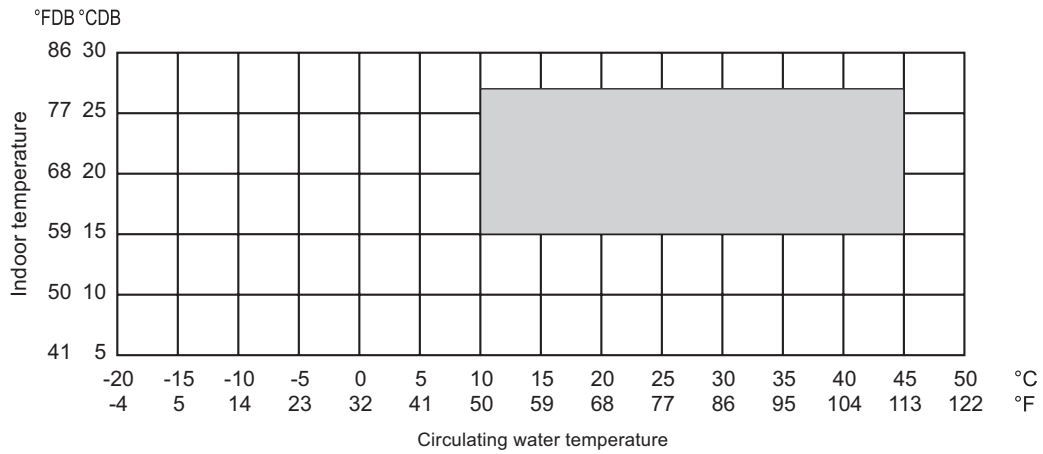

WY

7-1. Designing of water circuit system

1) Example of basic water circuit

The water circuit of the water heat source CITY MULTI connects the heat source unit with the cooling tower/auxiliary heat source/heat storage tank/circulation pump with a single system water piping as shown in the figure below. The selector valve automatically controls to circulate water toward the cooling tower in the cooling season, while toward the heat storage tank in the heating season. If the circulation water temperature is kept in a range of 10~45°C[50~113°F]* regardless of the building load, the water heat source CITY MULTI can be operated for either cooling or heating. Therefore in the summer when only cooling load exists, the temperature rise of circulation water will be suppressed by operating the cooling tower. While in the winter when heating load increases, the temperature of circulation water may be dropped below 10°C[50°F]. Under such situation, the circulation water will be heated with the auxiliary heat source if it drops below a certain temperature. When the thermal balance between cooling and heating operation is in a correct proportion, the operation of the

auxiliary heat source and cooling tower is not required. In order to control the above thermal balance properly and use thermal energy effectively, utilizing of heat storage tanks, and night-time discounted electric power as an auxiliary heat source will be economical. Meantime as this system uses plural sets of heat source unit equipped with water heat exchangers, water quality control is important. Therefore it is recommended to use closed type cooling towers as much as possible to prevent the circulation water from being contaminated. When open type cooling towers are used, it is essential to provide proper maintenance control such as that to install water treatment system to prevent troubles caused by contaminated circulation water.

Example of basic water circuit for water heat source CITY MULTI

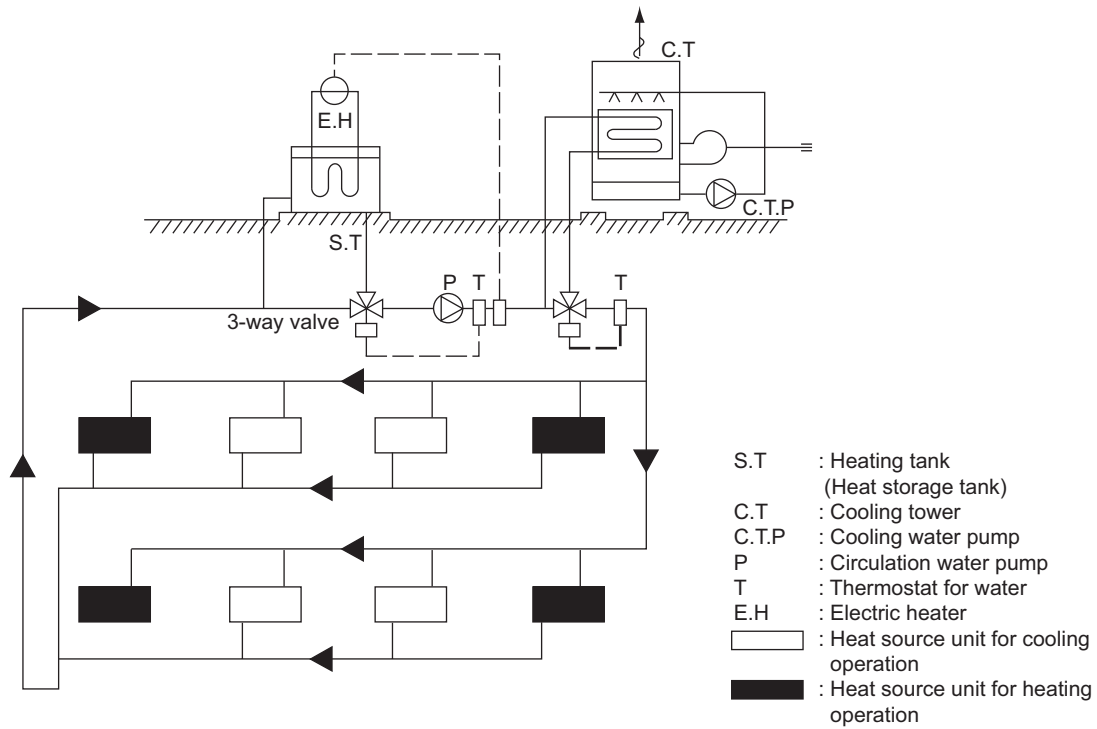

The indoor unit and refrigerant piping system are excluded in this figure.

WY

2) Cooling tower

a) Types of cooling tower

The cooling towers presently used include the open type cooling tower, open type cooling tower + heat exchanger, closed type cooling tower, and air-cooled type cooling tower. However, as the quality control of circulation water is essential when units are installed in decentralized state inside a building, the closed type cooling tower is generally employed in such case.

Although the circulation water will not be contaminated by atmospheric air, it is recommended to periodically blow water inside the system and replenish fresh water instead.

In a district where the coil may be frozen in the winter, it is necessary to apply antifreeze solution to the circulation water, or take freeze protection measures such as to automatically discharge water inside the cooling coil at the stopping of the pump.

When the open type cooling tower is used, be sure to install a water quality control device in addition to the freeze protection measures, as the water may be deteriorated by atmospheric contaminants entered into the cooling tower and dissolved into the circulation water.

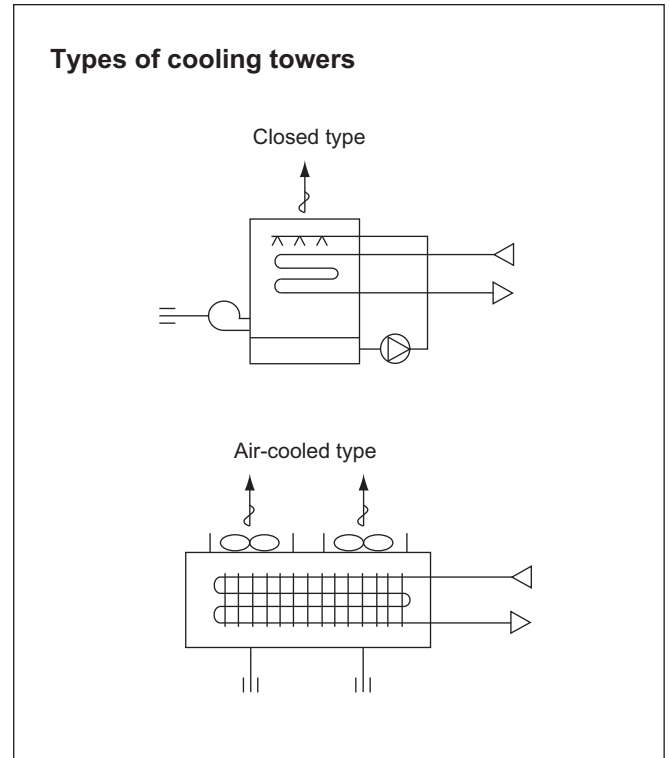

b) Calculation method of cooling tower capacity

All units of the water heat source CITY MULTI may possibly be in cooling operation temporarily (at pulling down) in the summer, however, it is not necessary to determine the capacity according to the total cooling capacity of all CITY MULTI units as this system has a wide operating water temperature range (10~45°C) [50~113°F].

It is determined in accordance with the value obtained by adding the maximum cooling load of an actual building, the input heat equivalent value of all CITY MULTI units, and the cooling load of the circulating pumps. Please check for the values of the cooling water volume and circulation water volume.

$$\text{Cooling tower capacity} = \frac{Q_c + 860 \times (\Sigma Q_w + P_w)}{3,900} \text{ (Refrigeration ton)}$$

- Q_c : Maximum cooling load under actual state (kcal/h)
- Q_w : Total input of water heat source CITY MULTI at simultaneous operation under maximum state (kW)
- P_w : Shaft power of circulation pumps (kW)

$$\text{Cooling tower capacity} = \frac{Q_c + 3,412 \times (\Sigma Q_w + P_w)}{15,500} \text{ (Refrigeration ton)}$$

- Q_c : Maximum cooling load under actual state (BTU/h)
- Q_w : Total input of water heat source CITY MULTI at simultaneous operation under maximum state (kW)
- P_w : Shaft power of circulation pumps (kW)

* 1 Refrigerant ton of cooling tower capacity ≈ US refrigerant ton x (1+0.3)
= 3,900 kcal/h = 15,500 BTU/h

3) Auxiliary heat source and heat storage tank

When the heating load is larger than the cooling load, the circulation water temperature lowers in accordance with the heat balance of the system. It should be heated by the auxiliary heat source in order to keep the inlet water temperature within the operating range (10°C[50°F] or more) of the water heat source CITY MULTI.

Further in order to operate the water heat source CITY MULTI effectively, it is recommended to utilize the heat storage tank to cover the warming up load in the morning and the insufficient heat amount.

Effective heat utilization can be expected to cover insufficient heat at the warming up in the next morning or peak load time by storing heat by installing a heat storage tank or operating a low load auxiliary heat source at the stopping of the water heat source CITY MULTI. As it can also be possible to reduce the running cost through the heat storage by using the discounted night-time electric power, using both auxiliary heat source and heat storage tank together is recommended.

Determining the auxiliary heat source capacity

For the CITY MULTI water heat source system, a heat storage tank is recommended to use. When employment of the heat storage tank is difficult, the warming up operation should be arranged to cover the starting up heating load. Since the holding water inside the piping circuit owns heat capacity and the warming up operation can be assumed for about one hour except that in a cold region, the heat storage tank capacity is required to

The effective temperature difference of an ordinary heat storage tank shows about 5deg. even with the storing temperature at 45°C[113°F].

However with the water heat source CITY MULTI, it can be utilized as heating heat source up to 15°C[59°F] with an effective temperature of a high 30deg°C[54deg°F]. approximately, thus the capacity of the heat storage tank can be minimized.

a) Auxiliary heat source

The following can be used as the auxiliary heat source.

- Boiler (Heavy oil, kerosine, gas, electricity)
- Electric heat (Insertion of electric heater into heat storage tank)
- Outdoor air (Air-heat source heat pump chiller)
- Warm discharge water (Exhaust water heat from machines inside building and hot water supply)
- Utilization of night-time lighting
- Solar heat

Please note that the auxiliary heat source should be selected after studying your operating environment and economical feasibility.

be that at the maximum daily heating load including the warming up load at the next morning of the holiday. However the auxiliary heat source capacity should be determined by the daily heating load including warming up load on the week day.

For the load at the next morning of the holiday, heat storage is required by operating the auxiliary heat source even outside of the ordinary working hour.

When heat storage tank is not used

$$QH = HCT \left(1 - \frac{1}{COP_h} \right) - 1000 \times Vw \times \Delta T - 860 \times Pw$$

- QH : Auxiliary heat source capacity (kcal/h)
- HCT : Total heating capacity of each water heat source CITY MULTI (kcal/h)
- COP_H : COP of water heat source CITY MULTI at heating
- Vw : Holding water volume inside piping (m³)
- ΔT : Allowable water temperature drop = T_{WH} - T_{WL} (°C)
- T_{WH} : Heat source water temperature at high temperature side (°C)
- T_{WL} : Heat source water temperature at low temperature side (°C)
- Pw : Heat source water pump shaft power (kW)

$$QH = HCT \left(1 - \frac{1}{COP_h} \right) - 8.343 \times Vw \times \Delta T - 3412 \times Pw$$

- QH : Auxiliary heat source capacity (BTU/h)
- HCT : Total heating capacity of each water heat source CITY MULTI (BTU/h)
- COP_H : COP of water heat source CITY MULTI at heating
- Vw : Holding water volume inside piping (G)
- ΔT : Allowable water temperature drop = T_{WH} - T_{WL} (°F)
- T_{WH} : Heat source water temperature at high temperature side (°F)
- T_{WL} : Heat source water temperature at low temperature side (°F)
- Pw : Heat source water pump shaft power (kW)

WY

When heat storage tank is not used

$$QH = \frac{HQ_{1T} \cdot \left(1 - \frac{1}{COP_h} \right) - 860 \times P_w \times T_2}{T_1} \times K \quad (\text{kcal})$$

- QH_{1T} : Total of heating load on weekday including warming up (kcal/day)
- T₁ : Operating hour of auxiliary heat source (h)
- T₂ : Operating hour of heat source water pump (h)
- K : Allowance factor (Heat storage tank, piping loss, etc.) 1.05~1.10

HQ_{1T} is calculated from the result of steady state load calculation similarly by using the equation below.
 $HQ_{1T} = 1.15 \times (\Sigma Q'a + \Sigma Q'b + \Sigma Q'c + \Sigma Q'd + \Sigma Q'f) T_2 - \psi (\Sigma Q'e_1 + \Sigma Q'e_2 + \Sigma Q'e_3) (T_2 - 1)$

- Q'a : Thermal load from external wall/roof in each zone (kcal/h)
- Q'b : Thermal load from glass window in each zone (kcal/h)
- Q'c : Thermal load from partition/ceiling/floor in each zone (kcal/h)
- Q'd : Thermal load by infiltration in each zone (kcal/h)
- Q'f : Fresh outdoor air load in each zone (kcal/h)
- Q'e₁ : Thermal load from human body in each zone (kcal/h)
- Q'e₂ : Thermal load from lighting fixture in each zone (kcal/h)
- Q'e₃ : Thermal load from equipment in each zone (kcal/h)
- ψ : Radiation load rate 0.6~0.8
- T₂ : Air conditioning hour

$$QH = \frac{HQ_{1T} \cdot \left(1 - \frac{1}{COP_h} \right) - 3,412 \times P_w \times T_2}{T_1} \times K \quad (\text{BTU})$$

- QH_{1T} : Total of heating load on weekday including warming up (BTU/day)
- T₁ : Operating hour of auxiliary heat source (h)
- T₂ : Operating hour of heat source water pump (h)
- K : Allowance factor (Heat storage tank, piping loss, etc.) 1.05~1.10

HQ_{1T} is calculated from the result of steady state load calculation similarly by using the equation below.
 $HQ_{1T} = 1.15 \times (\Sigma Q'a + \Sigma Q'b + \Sigma Q'c + \Sigma Q'd + \Sigma Q'f) T_2 - \psi (\Sigma Q'e_1 + \Sigma Q'e_2 + \Sigma Q'e_3) (T_2 - 1)$

- Q'a : Thermal load from external wall/roof in each zone (BTU/h)
- Q'b : Thermal load from glass window in each zone (BTU/h)
- Q'c : Thermal load from partition/ceiling/floor in each zone (BTU/h)
- Q'd : Thermal load by infiltration in each zone (BTU/h)
- Q'f : Fresh outdoor air load in each zone (BTU/h)
- Q'e₁ : Thermal load from human body in each zone (BTU/h)
- Q'e₂ : Thermal load from lighting fixture in each zone (BTU/h)
- Q'e₃ : Thermal load from equipment in each zone (BTU/h)
- ψ : Radiation load rate 0.6~0.8
- T₂ : Air conditioning hour

WY

b) Heat storage tank

Heat storage tank can be classified by types into the open type heat storage tank exposed to atmosphere, and the closed type heat storage tank with structure separated from atmosphere. Although the size of the tank and its installation place should be taken into account, the closed type tank is being usually employed

by considering corrosion problems.

The capacity of heat storage tanks is determined in accordance with the daily maximum heating load that includes warming up load to be applied for the day after the holiday.

When auxiliary heat source is operated during operation and even after stopping of water heat source CITY MULTI unit

$$V = \frac{HQ_{2T} \left(1 - \frac{1}{COP_h} \right) - 860 \times P_w \times T_2 - Q_H \times T_2}{\Delta T \times 1,000 \times \eta V} \quad (\text{ton})$$

HQ_{2T} : Maximum heating load including load required for the day after the holiday (kcal/day)
 ΔT : Temperature difference utilized by heat storage tank (deg°C)
 ηV : Heat storage tank efficiency

$$HQ_{2T} : 1.3 \times (\Sigma Q'a + \Sigma Q'c + \Sigma Q'd + \Sigma Q'f) T_2 - \psi(\Sigma Qe2 + \Sigma Qe3) (T_2 - 1)$$

$$V = \frac{HQ_{2T} \left(1 - \frac{1}{COP_h} \right) - 3,412 \times P_w \times T_2 - Q_H \times T_2}{\Delta T \times \eta V} \quad (\text{lbs})$$

HQ_{2T} : Maximum heating load including load required for the day after the holiday (BTU/day)
 ΔT : Temperature difference utilized by heat storage tank (deg°F)
 ηV : Heat storage tank efficiency

$$HQ_{2T} : 1.3 \times (\Sigma Q'a + \Sigma Q'c + \Sigma Q'd + \Sigma Q'f) T_2 - \psi(\Sigma Qe2 + \Sigma Qe3) (T_2 - 1)$$

When auxiliary heat source is operated after stopping of water heat source CITY MULTI unit

$$V = \frac{HQ_{2T} \left(1 - \frac{1}{COP_h} \right) - 860 \times P_w \times T_2}{\Delta T \times 1,000 \times \eta V} \quad (\text{ton})$$

HQ_{2T} : Maximum heating load including load required for the day after the holiday (kcal/day)
 ΔT : Temperature difference utilized by heat storage tank (deg°C)
 ηV : Heat storage tank efficiency

$$HQ_{2T} : 1.3 \times (\Sigma Q'a + \Sigma Q'c + \Sigma Q'd + \Sigma Q'f) T_2 - \psi(\Sigma Qe2 + \Sigma Qe3) (T_2 - 1)$$

$$V = \frac{HQ_{2T} \left(1 - \frac{1}{COP_h} \right) - 3,412 \times P_w \times T_2}{\Delta T \times \eta V} \quad (\text{lbs})$$

HQ_{2T} : Maximum heating load including load required for the day after the holiday (BTU/day)
 ΔT : Temperature difference utilized by heat storage tank (deg°F)
 ηV : Heat storage tank efficiency

$$HQ_{2T} : 1.3 \times (\Sigma Q'a + \Sigma Q'c + \Sigma Q'd + \Sigma Q'f) T_2 - \psi(\Sigma Qe2 + \Sigma Qe3) (T_2 - 1)$$

WY

4) Piping system

The following items should be kept in your mind in planning / designing water circuits.

- a) All units should be constituted in a single circuit in principle.
- b) When plural numbers of the water heat source CITY MULTI unit are installed, the rated circulating water flow rate should be kept by making the piping resistance to each unit almost same value. As an example, the reverse return system as shown below may be employed.
- c) Depending on the structure of a building, the water circuit may be prefabricated by making the layout uniform.
- d) When a closed type piping circuit is constructed, install an expansion tank usable commonly for a make-up water tank to absorb the expansion/contraction of water caused

by temperature fluctuation.

- e) If the operating temperature range of circulation water stays within the temperature near the normal temperature (summer : 29.4°C[85°F], winter : 21.1°C[70°F]), thermal insulation or anti-sweating work is not required for the piping inside buildings.

In case of the conditions below, however, thermal insulation is required.

- When well water is used for heat source water.
- When piped to outdoor or a place where freezing may be caused.
- When vapor condensation may be generated on piping due to an increase in dry bulb temperature caused by the entry of fresh outdoor air.

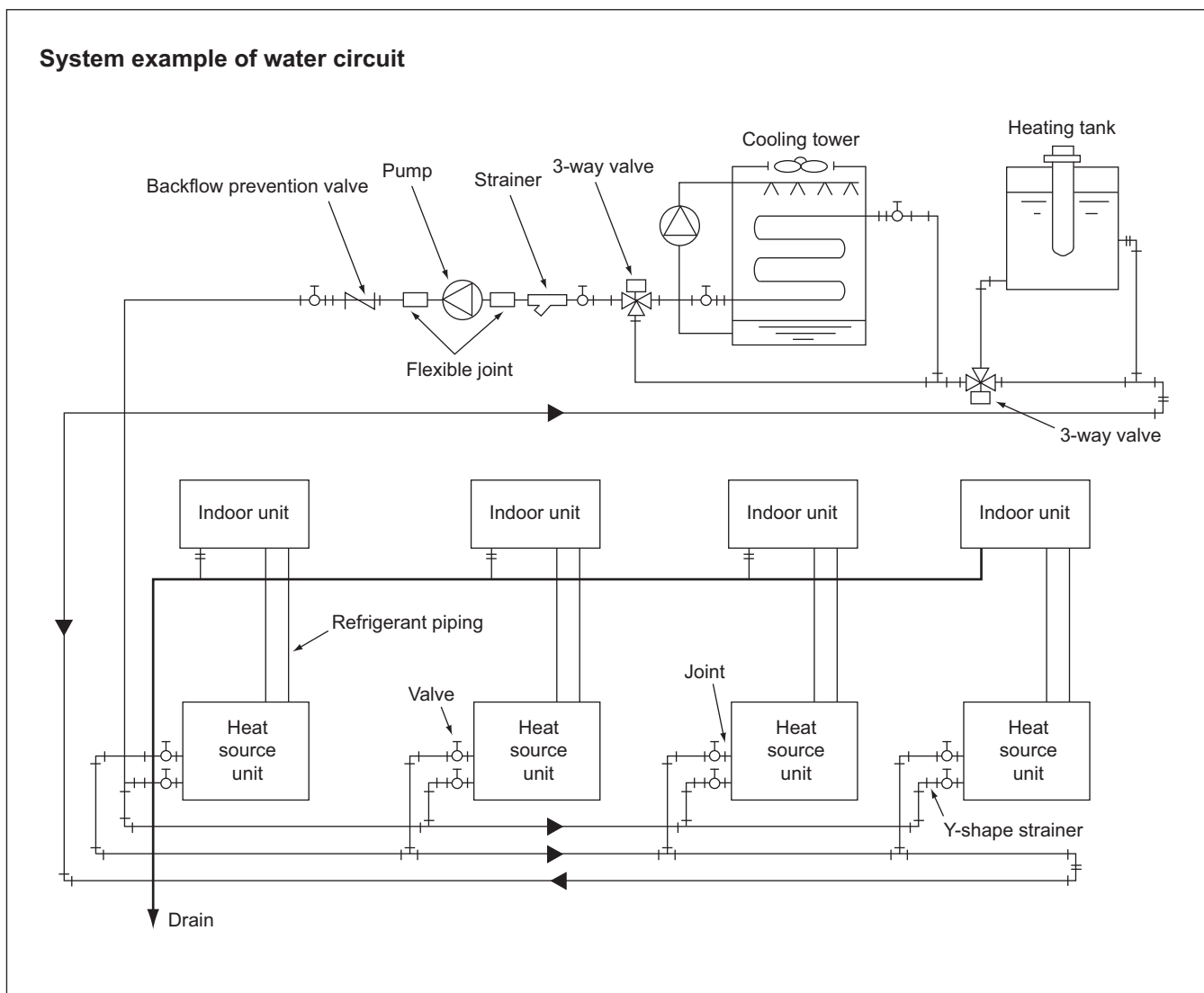

WY

5) Practical System Examples and Circulation Water Control

Since the water heat source CITY MULTI is of water heat source system, versatile systems can be constituted by combining it with various heat sources. The practical system examples are given below. Either cooling or heating operation can be performed if the circulation water temperature of the water heat source CITY MULTI stays within a range of 10~45°C

[50~113°F]. However, the circulation water temperature near 32°C[90°F] for cooling and 20°C[68°F] for heating is recommended by taking the life, power consumption and capacity of the air conditioning units into consideration. The detail of the control is also shown below.

Example-1 Combination of closed type cooling tower and hot water heat storage tank (using underground hollow slab)

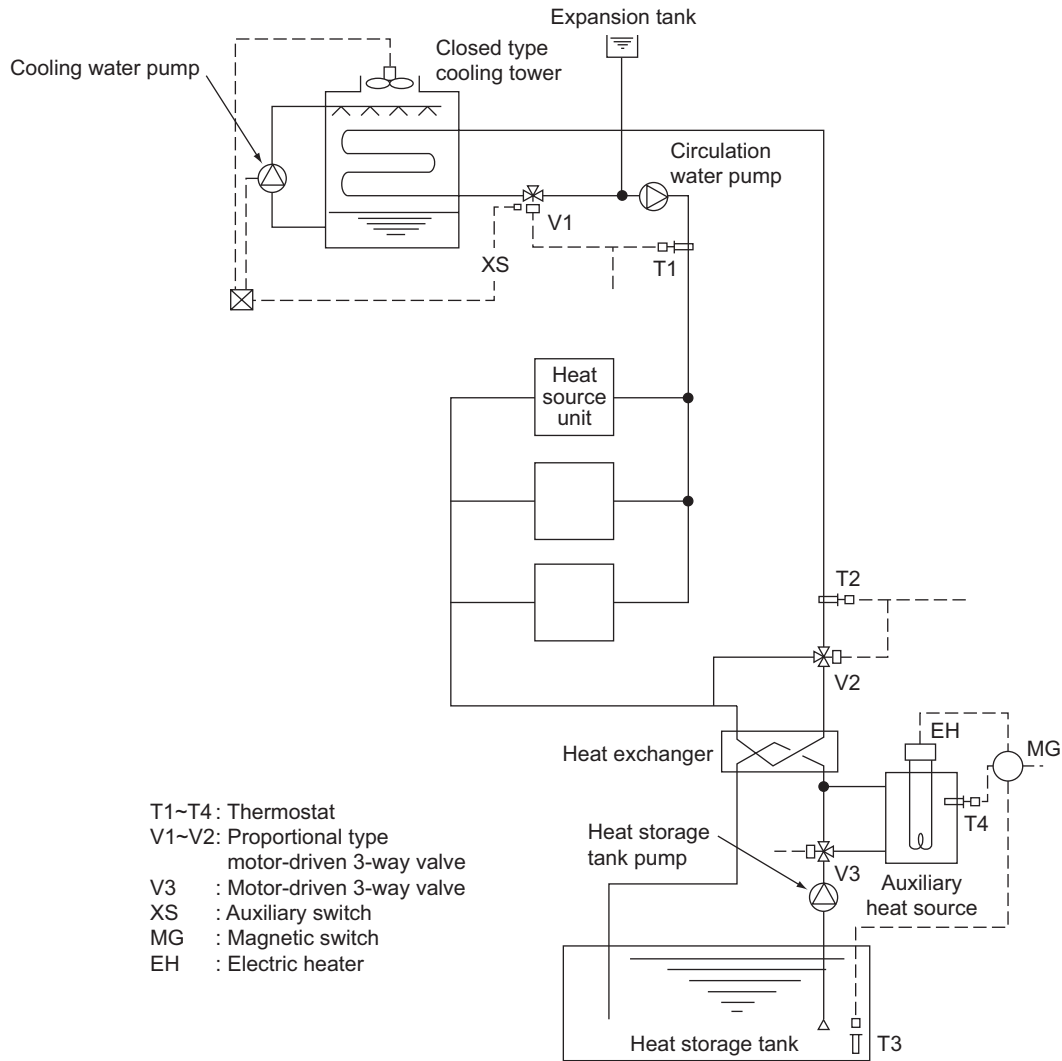

By detecting the circulation water temperature of the water heat source CITY MULTI system with T1 (around 32°C[90°F]) and T2 (around 20°C[68°F]), the temperature will be controlled by opening/closing V1 in the summer and V2 in the winter.

In the summer, as the circulation water temperature rises exceeding the set temperature of T1, the bypass port of V1 will open to lower the circulation water temperature. While in the winter, as the circulation water temperature drops, V2 will open following the command of T2 to rise the circulation water temperature.

The water inside the heat storage tank will be heated by the auxiliary heat source by V3 being opened with timer operation in the night-time. The electric heater of the auxiliary heat source will be controlled by T3 and the timer. The start/stop control of the fan and pump of the closed type cooling tower is applied with the step control of the fan and pump following the command of the auxiliary switch XS of V1, that operates only the fan at the light load while the fan and pump at the maximum load thus controlling water temperature and saving motor power.

WY

Example-2 Combination of closed type cooling tower and hot water heat storage tank

- T1 : Proportional type, insertion system thermostat
 T2 : Proportional type, insertion system thermostat
 T3 : Proportional type, insertion system thermostat
 V1 : Proportional type, motor-driven 3-way valve
 V2 : Proportional type, motor-driven 3-way valve
 XS : Auxiliary switch (Duplex switch type)
 SC : Step controller
 R : Relay
 MG : Magnetic

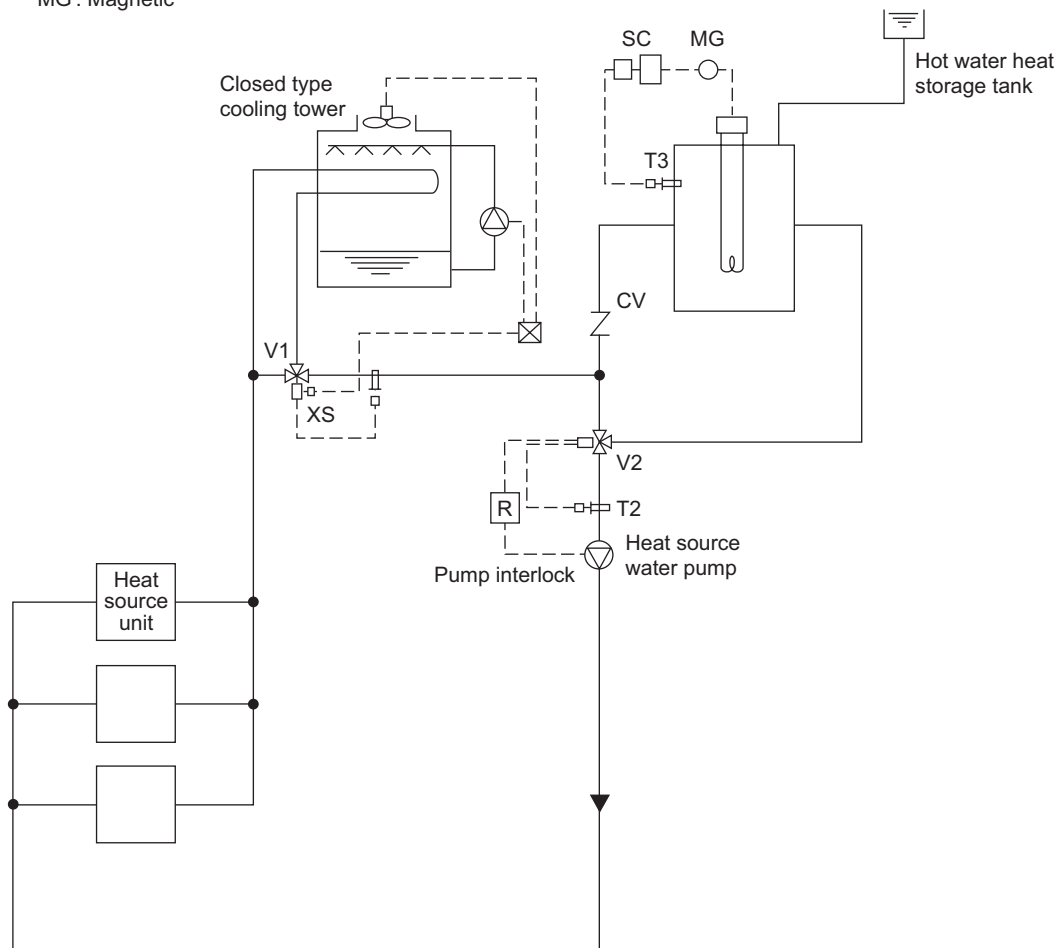

In the summer, as the circulation water temperature rises exceeding the set temperature of T1, the bypass port of V1 will open to lower the circulation water temperature. In the winter, if the circulation water temperature stays below 25°C[77°F], V2 will open/close by the command of T2 to keep the circulation water temperature constant.

The temperature of the hot water inside the heat storage tank will be controlled through the step control of the electric heater by step controller operation following the command of T3.

During the stopping of the heat source water pump, the bypass port of V2 will be closed fully by interlocking thus preventing the high temperature water from entering into the system at the starting of the pump.

The start/stop control of the fan and pump of the closed type cooling tower is applied with the step control of the fan and pump following the command of the auxiliary switch XS of V1, that operates only the fan at the light load while the fan and pump at the maximum load thus controlling water temperature and saving motor power.

Example-3 Combination of closed type cooling tower and boiler

- T1 : Proportional type, insertion system thermostat
- T2 : Proportional type, insertion system thermostat
- T3 : Proportional type, insertion system thermostat
- V1 : Proportional type, motor-driven 3-way valve
- S : Selector switch
- R : Relay
- XS : Auxiliary switch (Duplex switch type)

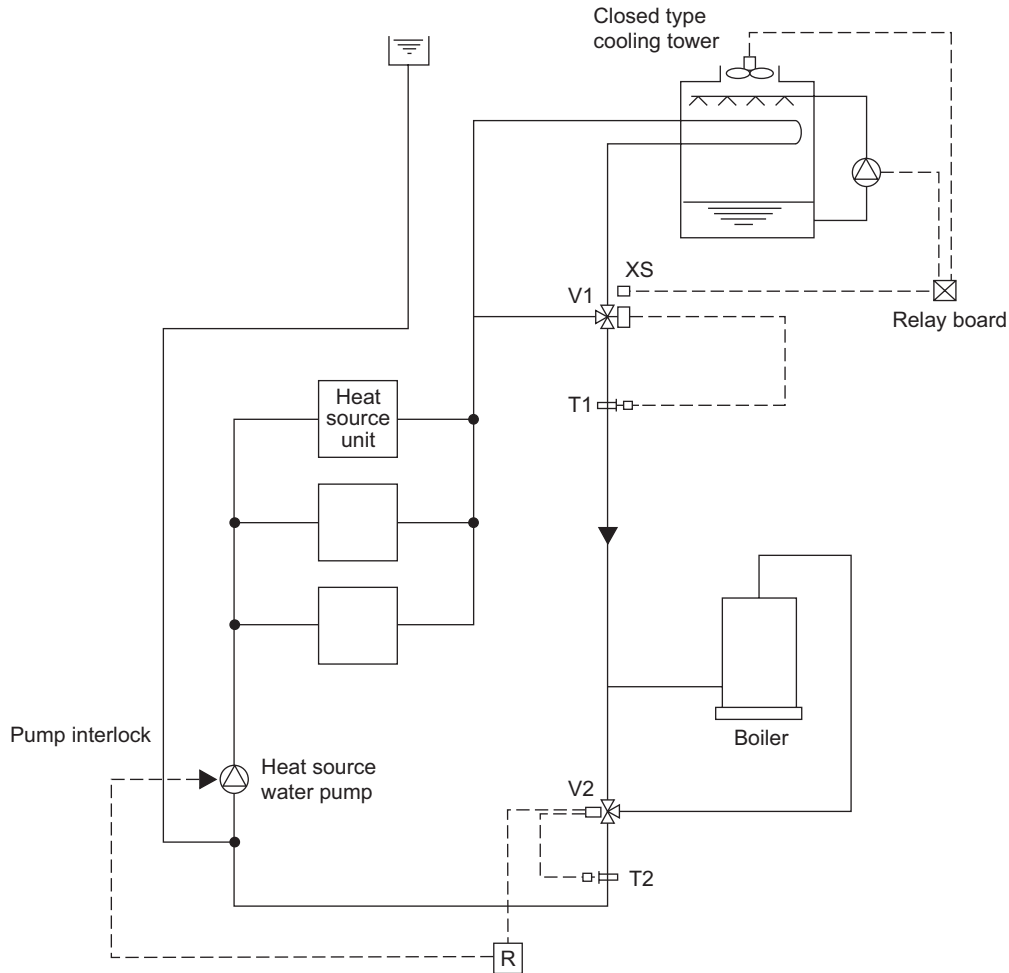

In the summer, as the circulation water temperature rises exceeding the set temperature of T1, the bypass port of V1 will close to lower the circulation water temperature. In the winter, if the circulation water temperature drops below 25°C[77°F], V2 will conduct water temperature control to keep the circulation water temperature constant. During the stopping of the heat source water pump, the bypass port of V2 will be closed fully by interlocking. The start/stop control of the fan and pump of the closed type cooling tower is applied with the step control following the command of the auxiliary switch XS of V1, thus controlling water temperature and saving motor power.

WY

Example-4 Combination of closed type cooling tower and heat exchanger (of other heat source)

- T1 : Proportional type, insertion system thermostat
 T2 : Proportional type, insertion system thermostat
 V1 : Proportional type, motor-driven 3-way valve
 V2 : Proportional type, motor-driven 3-way valve
 S : Selector switch
 R : Relay
 XS : Auxiliary switch (Duplex switch type)

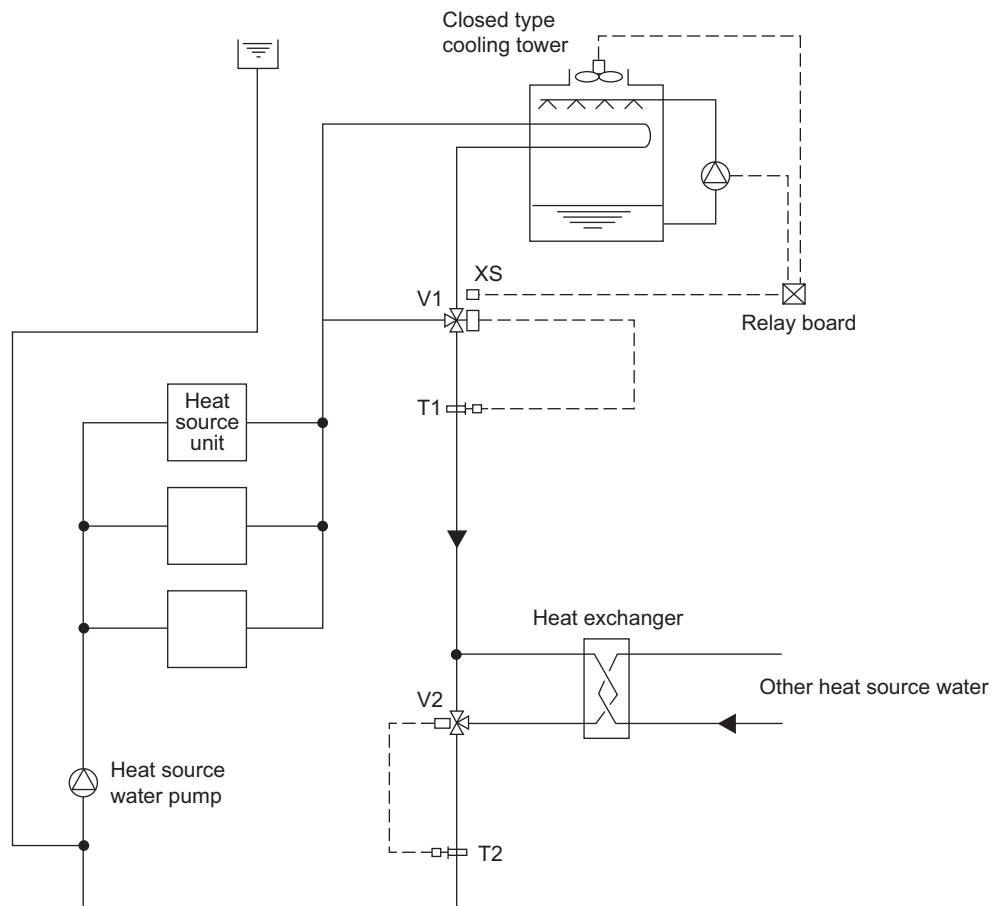

In the summer, as the circulation water temperature rises exceeding the set temperature of T1, the bypass port of V1 will close to lower the circulation water temperature. In the winter, if the circulation water temperature drops below 26°C[79°F], V2 will conduct water temperature control to keep the circulation water temperature constant. During the stopping of the heat source water pump, the bypass port of V2 will be closed fully by interlocking. The start/stop control of the fan and pump of the closed type cooling tower is applied with the step control following the command of the auxiliary switch XS of V1, thus controlling water temperature and saving motor power.

6) Pump interlock circuit

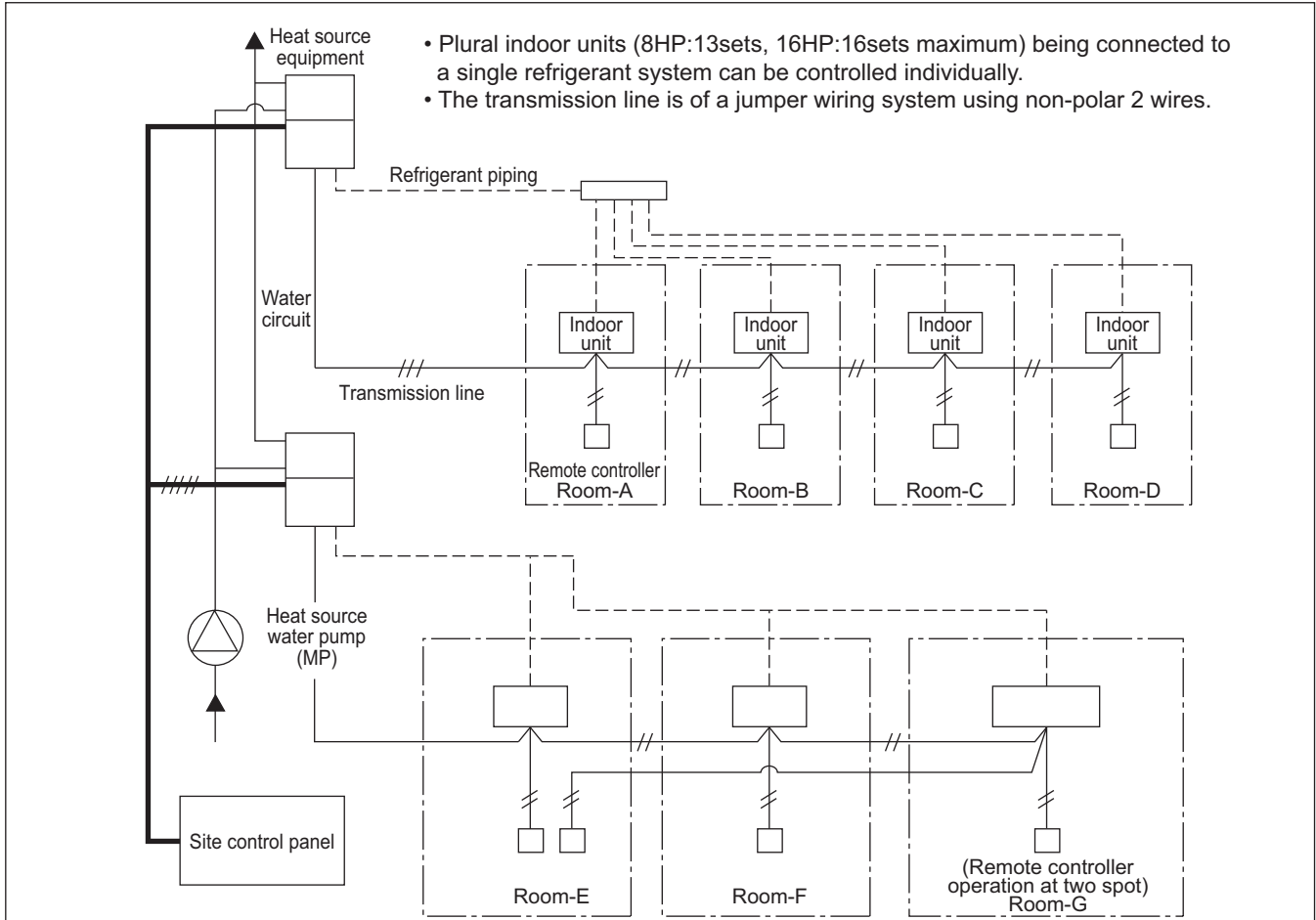

Wiring diagram

This circuit uses the "Terminal block for pump interlock (TB8)" inside the electrical parts box of the heat source equipment. This circuit is for interlocking the heat source equipment operation and the heat source water pump.

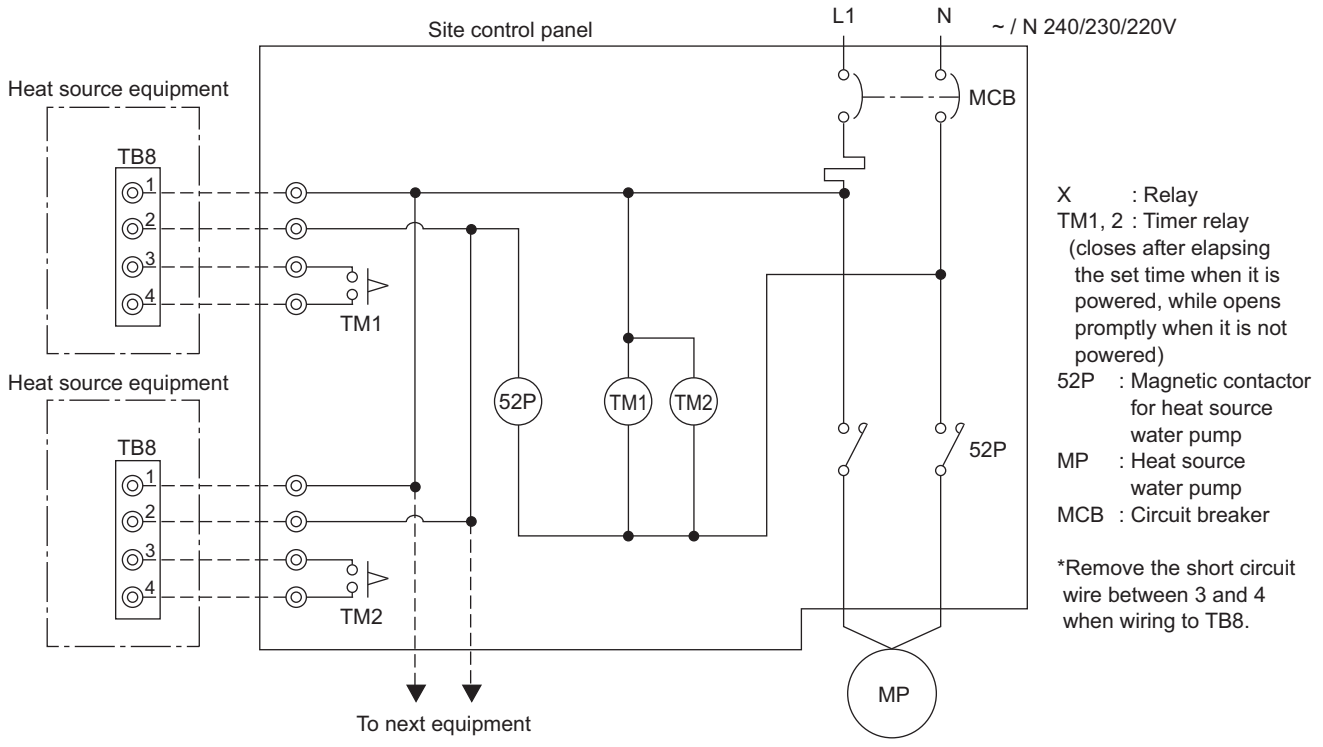

Operation ON signal

Terminal No.	TB8-1, 2
Output	Relay contacts output Rated voltage : L1 - N : 220 ~ 240V Rated load : 1A
Operation	<ul style="list-style-type: none"> • When Dip switch 2-7 is OFF The relay closes during compressor operation. • When DIP switch 2-7 is ON. The relay closes during reception of cooling or the heating operation signal from the controller. (Note : It is output even if the thermostat is OFF (when the compressor is stopped).)

Pump Interlock

Terminal No.	TB8-3, 4
Input	Level signal
Operation	If the circuit between TB8-3 and TB8-4 is open, compressor operation is prohibited.

7-2. Water piping work

Although the water piping for the CITY MULTI WY system does not differ from that for ordinary air conditioning systems, pay special attention to the items below in conducting the piping work.

1) Items to be observed on installation work

- In order to equalize piping resistance for each unit, adapt the reverse return system.
- Mount a joint and a valve onto the water outlet/inlet of the unit to allow for maintenance, inspection and replacement work. Be sure to mount a strainer at the water inlet piping of the unit. (The strainer is required at the circulation water inlet to protect the heat source unit.)
- * The installation example of the heat source unit is shown right.
- Be sure to provide an air relief opening on the water piping properly, and purge air after feeding water to the piping system.
- Condensate will generate at the low temperature part inside the heat source equipment. Connect drain piping to the drain piping connection located at the bottom of the heat source equipment to discharge it outside the equipment.
- At the center of the header of the heat exchanger water inlet inside the unit, a plug for water discharge is being provided. Use it for maintenance work or the like.
- Mount a backflow prevention valve and a flexible joint for vibration control onto the pump.
- Provide a sleeve to the penetrating parts of the wall to prevent the piping.
- Fasten the piping with metal fitting, arrange the piping not to expose to cutting or bending force, and pay sufficient care for possible vibration.
- Be careful not to erroneously judge the position of the inlet and outlet of water.
(Lower position : Inlet, Upper position : Outlet)
- When connecting heat source unit water piping and water piping on site, apply liquid sealing material for water piping over the sealing tape before connection. (for Maximum water pressure above 1.0MPa)
- Wrap the sealing tape as follows.
- a) Wrap the joint with sealing tape in the direction of the threads (clockwise), and do not let the tape run over the edge.
- b) Overlap the sealing tape by two-thirds to three-fourths of its width on each turn. Press the tape with your fingers so that it is pressed firmly against each thread.
- c) Leave the 1.5th through 2nd farthest threads away from the pipe end unwrapped.
- Hold the pipe on the unit side in place with a spanner when installing the pipes or strainer. Tighten screws to a torque of 150N · m.

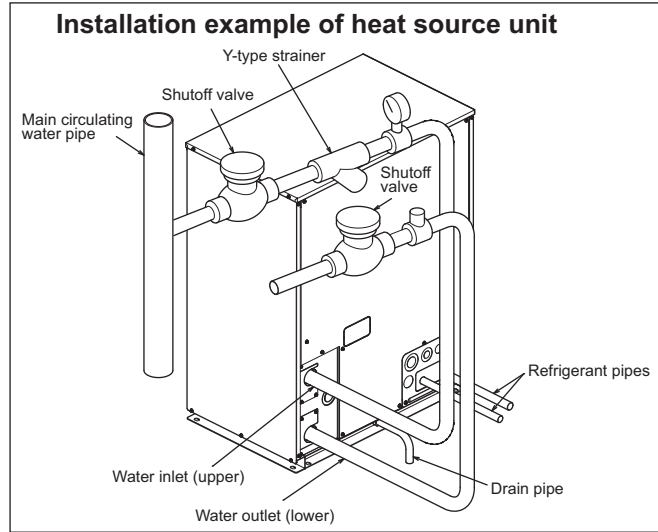

- piping due to an increase in dry bulb temperature inside the ceiling caused by the entry of fresh outdoor air
- Drain piping portions

3) Water treatment and water quality control

For the circulation water cooling tower of the CITY MULTI WY system, employment of the closed type is recommended to keep water quality. However, in the case that an open type cooling tower is employed or the circulating water quality is inferior, scale will adhere onto the water heat exchanger leading to the decreased heat exchange capacity or the corrosion of the heat exchanger. Be sufficiently careful for water quality control and water treatment at the installation of the circulation water system.

- Removal of impurities inside piping
Be careful not to allow impurities such as welding fragment, remaining sealing material and rust from mixing into the piping during installation work.
- Water treatment
The water quality standards have been established by the industry (Japan Refrigeration, Air Conditioning Industry Association, in case of Japan) for water treatment to be applied.

2) Thermal insulation work

Thermal insulation or anti sweating work is not required for the piping inside buildings in the case of the CITY MULTI WY system if the operating temperature range of circulation water stays within the temperature near the normal (summer : 29.4°C[85°F], winter : 21.1°C[70°F]). In case of the conditions below, however, thermal insulation is required.

- Use of well water for heat source water
- Outdoor piping portions
- Indoor piping portions where freezing may be caused in winter
- A place where vapor condensation may be generated on

Items	Lower mid-range temperature water system		Tendency	
	Recirculating water [20<T<60°C] [68<T<140°F]	Make-up water	Corrosive	Scale-forming
pH (25°C[77°F])	7.0 ~ 8.0	7.0 ~ 8.0	○	○
Electric conductivity (mS/m) (25°C[77°F])	30 or less	30 or less	○	○
(μS/cm) (25°C[77°F])	[300 or less]	[300 or less]		
Chloride ion (mg Cl/l)	50 or less	50 or less	○	
Sulfate ion (mg SO ₄ ²⁻ /l)	50 or less	50 or less	○	
Acid consumption (pH4.8) (mg CaCO ₃ /l)	50 or less	50 or less		○
Total hardness (mg CaCO ₃ /l)	70 or less	70 or less		○
Calcium hardness (mg CaCO ₃ /l)	50 or less	50 or less		○
Ionic silica (mg SiO ₂ /l)	30 or less	30 or less		○
Iron (mg Fe/l)	1.0 or less	0.3 or less	○	○
Copper (mg Cu/l)	1.0 or less	0.1 or less	○	
Sulfide ion (mg S ²⁻ /l)	not to be detected	not to be detected	○	
Ammonium ion (mg NH ₄ ⁺ /l)	0.3 or less	0.1 or less	○	
Residual chlorine (mg Cl/l)	0.25 or less	0.3 or less	○	
Free carbon dioxide (mg CO ₂ /l)	0.4 or less	4.0 or less	○	
Ryzner stability index	-	-	○	○

Reference : Guideline of Water Quality for Refrigeration and Air Conditioning Equipment. (JRA GL02E-1994)

In order to keep the water quality within such standards, you are kindly requested to conduct bleeding-off by overflow and periodical water quality tests, and use inhibitors to suppress condensation or corrosion. Since piping may be corroded by some kinds of inhibitor, consult an appropriate water treatment expert for proper water treatment.

4) Pump interlock

Operating the heat source unit without circulation water inside the water piping can cause a trouble. Be sure to provide interlocking for the unit operation and water circuit. Since the terminal block is being provided inside the unit, use it as required.

8-1. JOINT

Piping for CITY MULTI can be easily done with Joints and headers provided by MITSUBISHI ELECTRIC CORP.. There are 4 sets of Joints selectable for piping. Details for applying the Joint sets are referable to System Design 3, or their own Installation Manual.

CMY-Y102S-G2 mm

For Gas pipe: For Liquid pipe:

<Deformed pipe(Accessory)>

<Deformed pipe(Accessory)>

ID: Inner Diameter OD: Outer Diameter

CMY-Y102L-G2 mm

For Gas pipe: For Liquid pipe:

<Deformed pipe(Accessory)>

<Deformed pipe(Accessory)>

ID: Inner Diameter OD: Outer Diameter

CMY-Y202-G2 mm

For Gas pipe: For Liquid pipe:

<Deformed pipe(Accessory)>

<Deformed pipe(Accessory)>

ID: Inner Diameter OD: Outer Diameter

mm

CMY-Y302-G2

For Gas pipe:

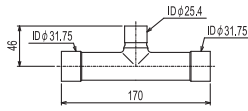

<Deformed pipe(Accessory)>

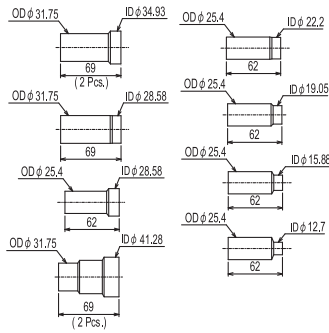

For Liquid pipe:

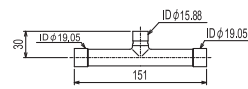

<Deformed pipe(Accessory)>

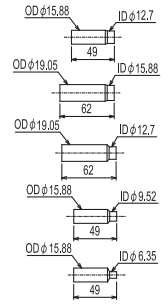

ID: Inner Diameter OD: Outer Diameter

WY

8-2. HEADER

Piping for CITY MULTI can be easily done with Joints and Headers provided by MITSUBISHI ELECTRIC CORP.. There are 3 sets of Headers selectable for piping. Details for applying the Header sets are referable to System Design 3, or their own Installation Manual.

CMY-Y104-G mm

For Gas pipe:

For Liquid pipe:

ID: Inner Diameter OD: Outer Diameter
NOTE: Besides above mentioned accessories, caps for pipe of $\phi 6.35$, $\phi 9.52$, $\phi 12.7$, $\phi 15.88$ (each diameter 1 piece) are included in the Header set.

CMY-Y108-G mm

For Gas pipe:

For Liquid pipe:

ID: Inner Diameter OD: Outer Diameter
NOTE: Besides above mentioned accessories, caps for pipe of $\phi 6.35$, $\phi 9.52$, $\phi 12.7$, $\phi 15.88$ (each diameter 2 pieces) and 1 cap for pipe of $\phi 19.05$ are included in the Header set.

CMY-Y1010-G mm

For Gas pipe:

For Liquid pipe:

ID: Inner Diameter OD: Outer Diameter
NOTE: Besides above mentioned accessories, caps for pipe of $\phi 6.35$, $\phi 9.52$, $\phi 12.7$, $\phi 15.88$ (each diameter 2 pieces) and 1 cap for pipe of $\phi 19.05$ are included in the Header set.

WY

8-3. OUTDOOR TWINNING KIT

For PQHY-P-YSHM, following optional Outdoor Twinning Kit is needed to use to combine to refrigerant flows of its PQHY-P-YHM. Details of selecting the proper kit should be referred to the System Design Section.

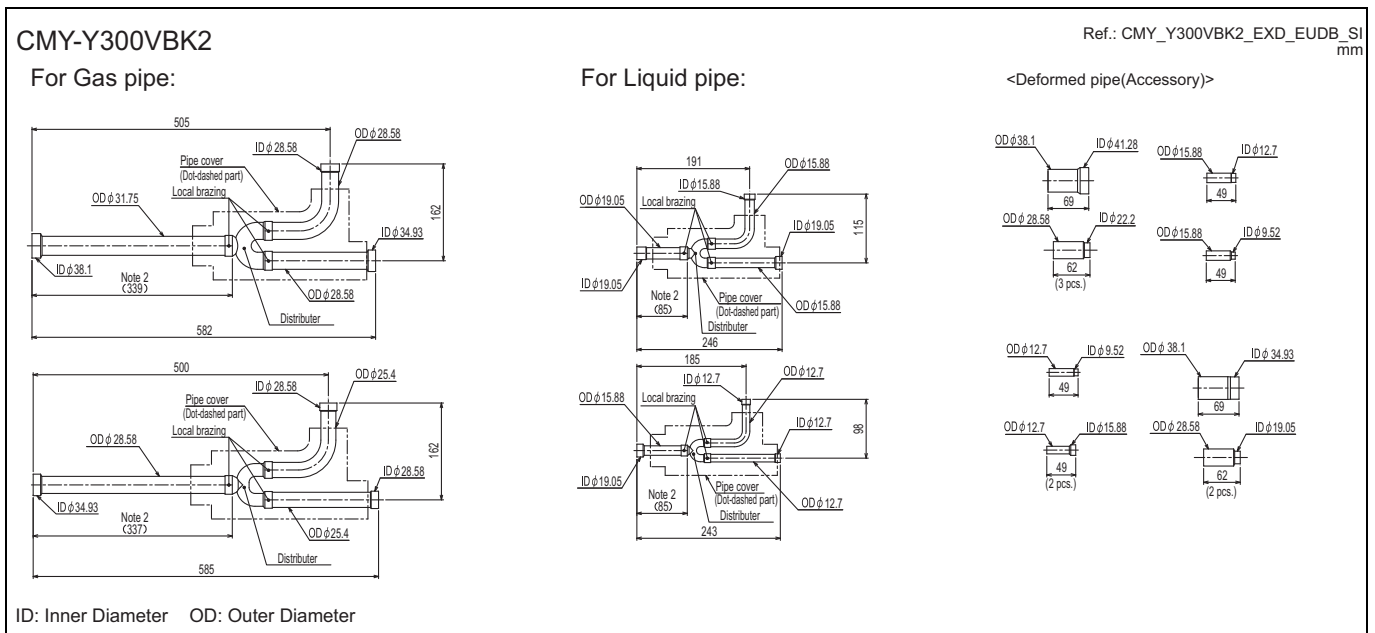
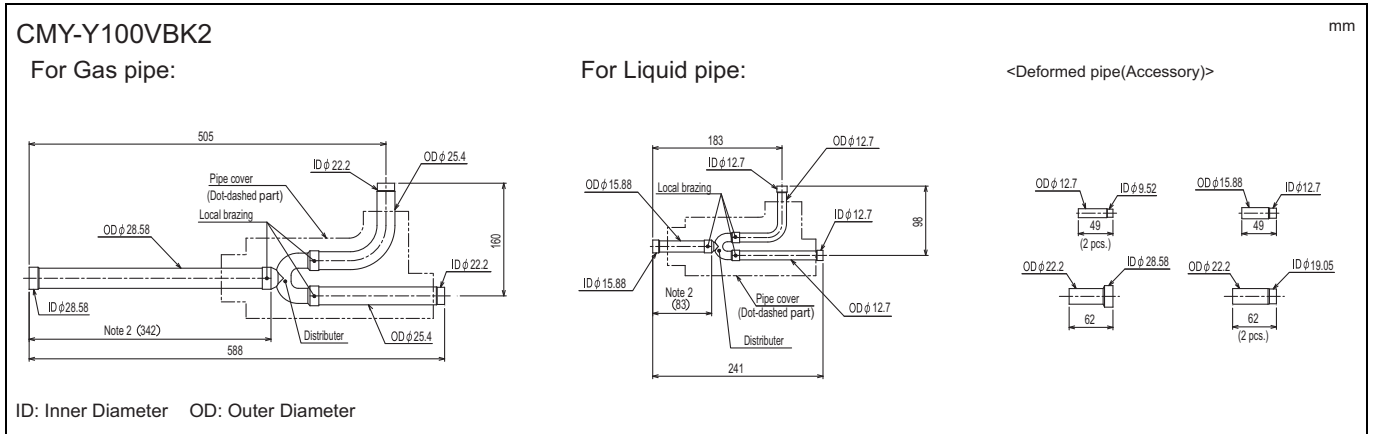

Note 1. Reference the attitude angle of the branch pipe below the fig.

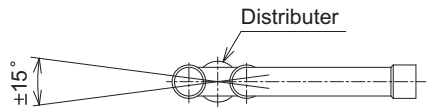

The angle of the branch pipe is within $\pm 15^\circ$ against the horizontal plane.

2. Use the attached pipe to braze the port-opening of the distributor.
3. Pipe diameter is indicated by inside diameter.

